

Таблица разводки цепей питания

Номинал напряжения	Устройства	Конт.
+5В	D1, D4, D14...D18, D21...D25, D36	15
	D5...D9, D11...D13, D19, D20, D25...D28, D32, D33, D35, D38, D39	14
	XP1	
	D51, XP2	24, 21
	D29, D31, D34, D37, D40	42
	D52...D533	8
	A1...A3, A75	9
	A4...14, A16, A17	1
	D1...D4, D14...D18, D21...D25, D36, E1...E3, E10, E11	8
	D5...D9, D11...D13, D19, D20, D25...D28, D32, D33, D35, D38, D39	7
ОБЩИИ	D1	1
	DS1, XP2	12
	D29, D31, D34, D37, D40	21
	D52...D533	16

Гл. конструктор. [Signature] / В.Е. Осипов. /

1. L3 устанавливается при
соединении 565 P45-D1.

518 выемка прорезью
-79

место переключателя S1, S2, S3
перемычки проволокой мм 0,6

ЩИЗ.059.064-0133

Микро-ЭВМ

Электроника МС 20102-01

Схема электрическая
принципиальная

Лист 1 Листов 3

Формат А1

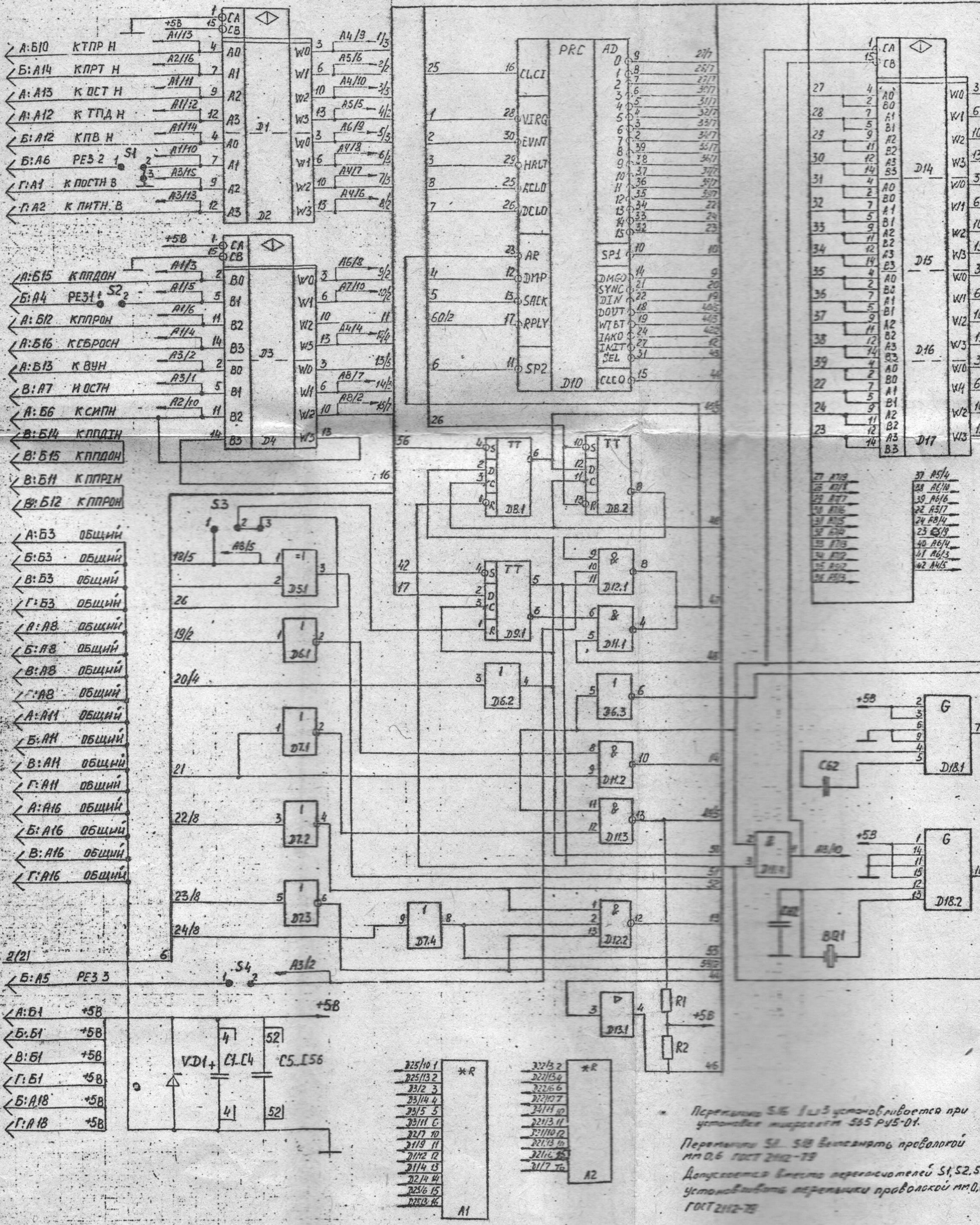

ШИВ. 059. 050 - 01
 10.12.86
 10844

- | | |
|----------|----|
| 225/10 1 | *R |
| 225/13 2 | |
| 23/2 3 | |
| 23/14 4 | |
| 23/5 5 | |
| 23/11 6 | |
| 227 10 | |
| 2119 11 | |
| 2112 12 | |
| 2114 13 | |
| 22/14 14 | |
| 225/6 15 | |
| 225/8 16 | |
-
- | | |
|-----------|----|
| 327/3 2 | *R |
| 327/15 4 | |
| 322/6 6 | |
| 322/7 7 | |
| 34/1 10 | |
| 321/10 12 | |
| 321/13 14 | |
| 321/6 15 | |
| 31/7 16 | |

Переключатель S6 1/13 устанавливается при установке микросхем 565 PУ5-01.
 Переключатель S1, S8 выключить праволкой мм 0,6 ГОСТ 2142-79
 Допускается вместо переключателей S1, S2, S3 устанавливать переключики праволкой мм 0,6 ГОСТ 2142-79

ЭС10-490 Б50 ЭИ177

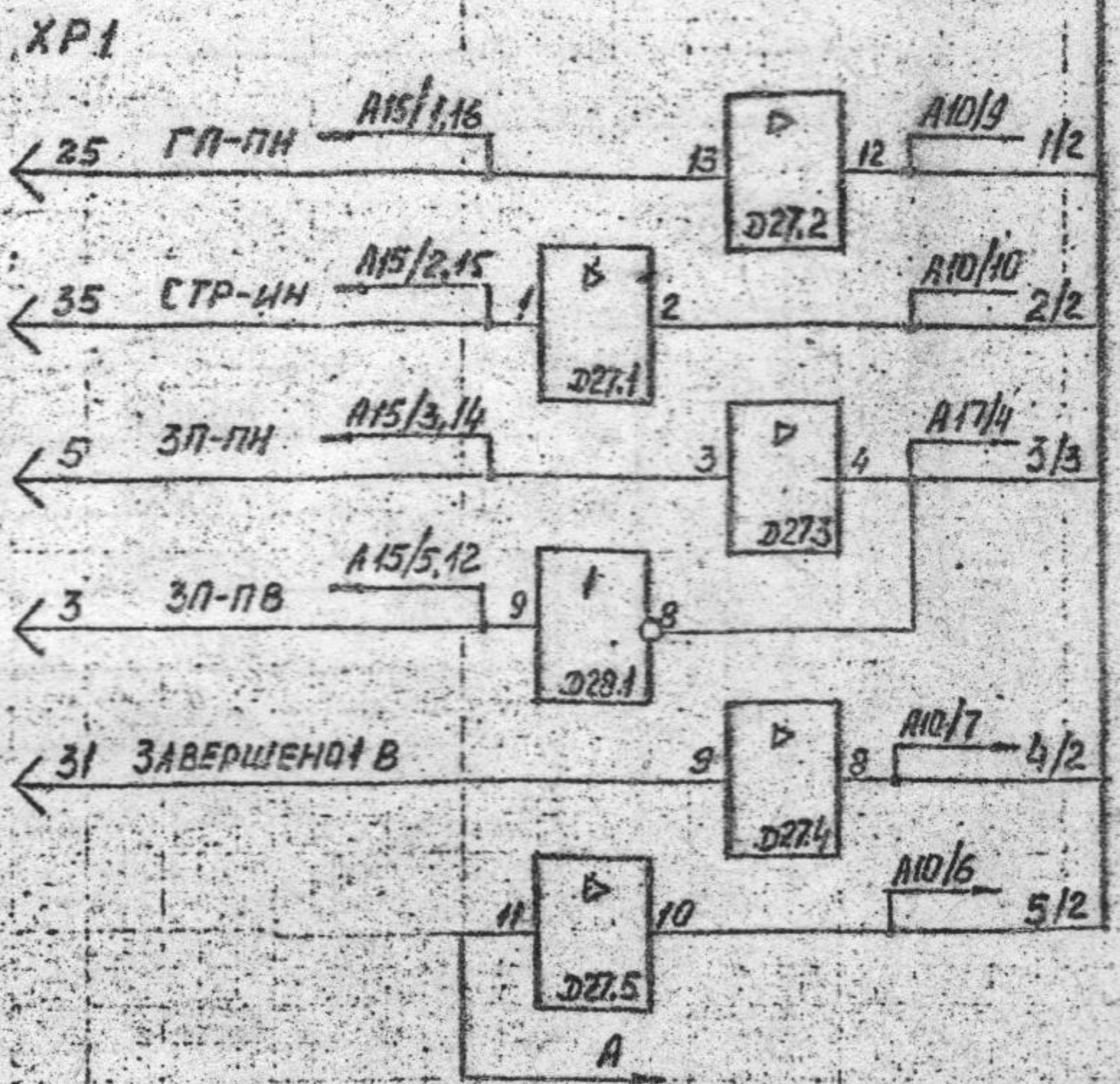

- 2 ОБЩИЙ
- 4 ОБЩИЙ
- 6 ОБЩИЙ
- 8 ОБЩИЙ
- 10 ОБЩИЙ
- 12 ОБЩИЙ
- 14 ОБЩИЙ
- 16 ОБЩИЙ
- 18 ОБЩИЙ
- 20 ОБЩИЙ
- 22 ОБЩИЙ
- 24 ОБЩИЙ
- 26 ОБЩИЙ
- 28 ОБЩИЙ
- 30 ОБЩИЙ
- 32 ОБЩИЙ
- 34 ОБЩИЙ
- 36 ОБЩИЙ
- 38 ОБЩИЙ
- 40 ОБЩИЙ

D4/5 1	*R
D4/2 2	
D24/3 3	
D24/13 4	
D23/3 5	
D24/6 6	
D24/10 7	
D25/10 10	
D25/6 11	
D12/10 12	
D21/2 13	
D23/12 14	
D21/9 15	
A5	
D6/1 3	*R
D3/13 4	
D10/23 5	
D21/3 6	
D21/10 7	
D21/6 8	
D1/3 9	
D11/10 10	
A4	
D10/39 2	*R
D10/38 3	
D10/55 6	
D3/3 8	
D2/3 9	
D10/56 10	
A6	
D10/2 2	*R
D10/3 3	
D10/4 4	
D10/5 5	
D10/6 6	
D10/7 7	
D10/8 8	
D10/9 9	
D3/6 10	
A7	

2(1)
1(1)

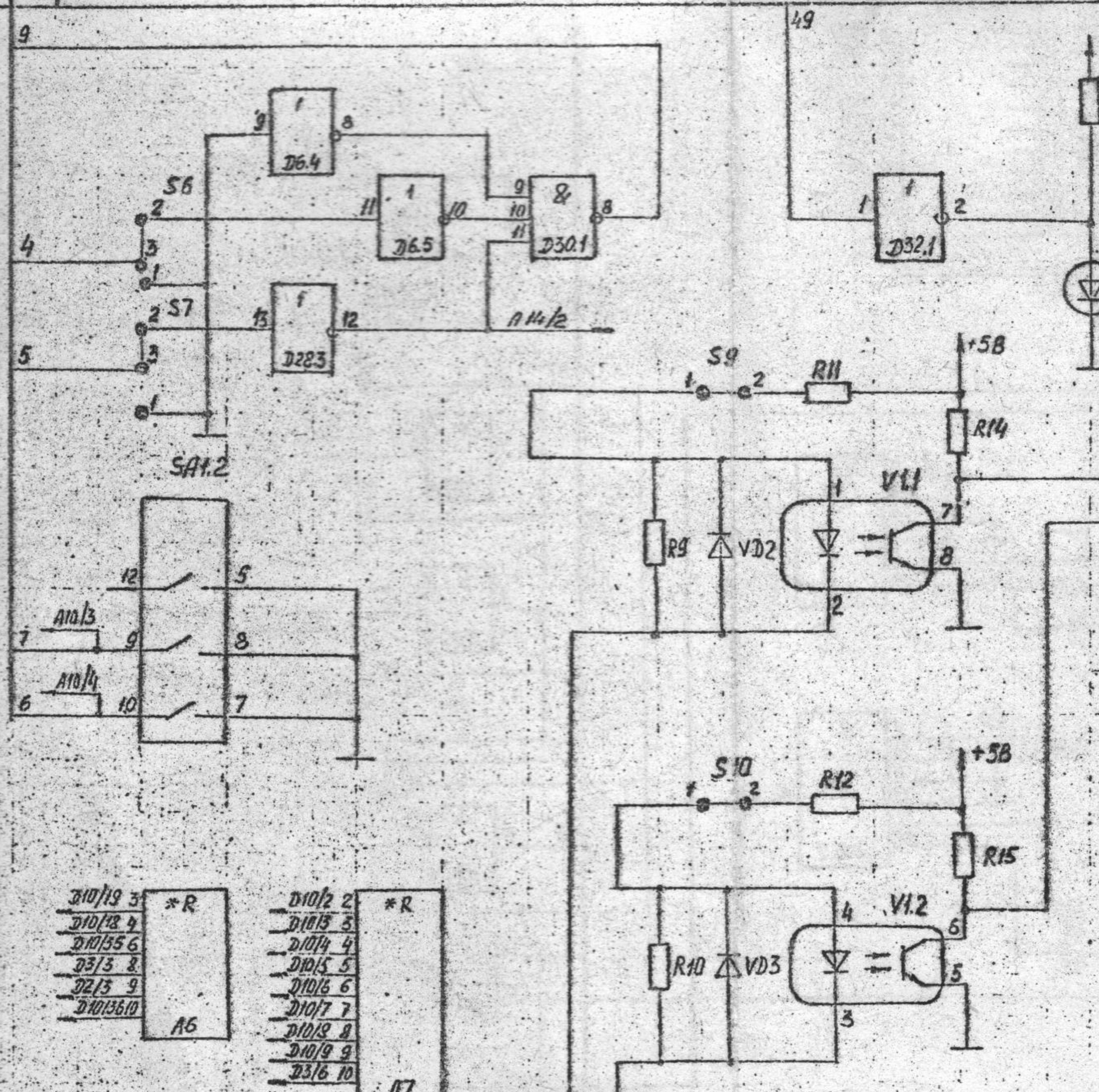
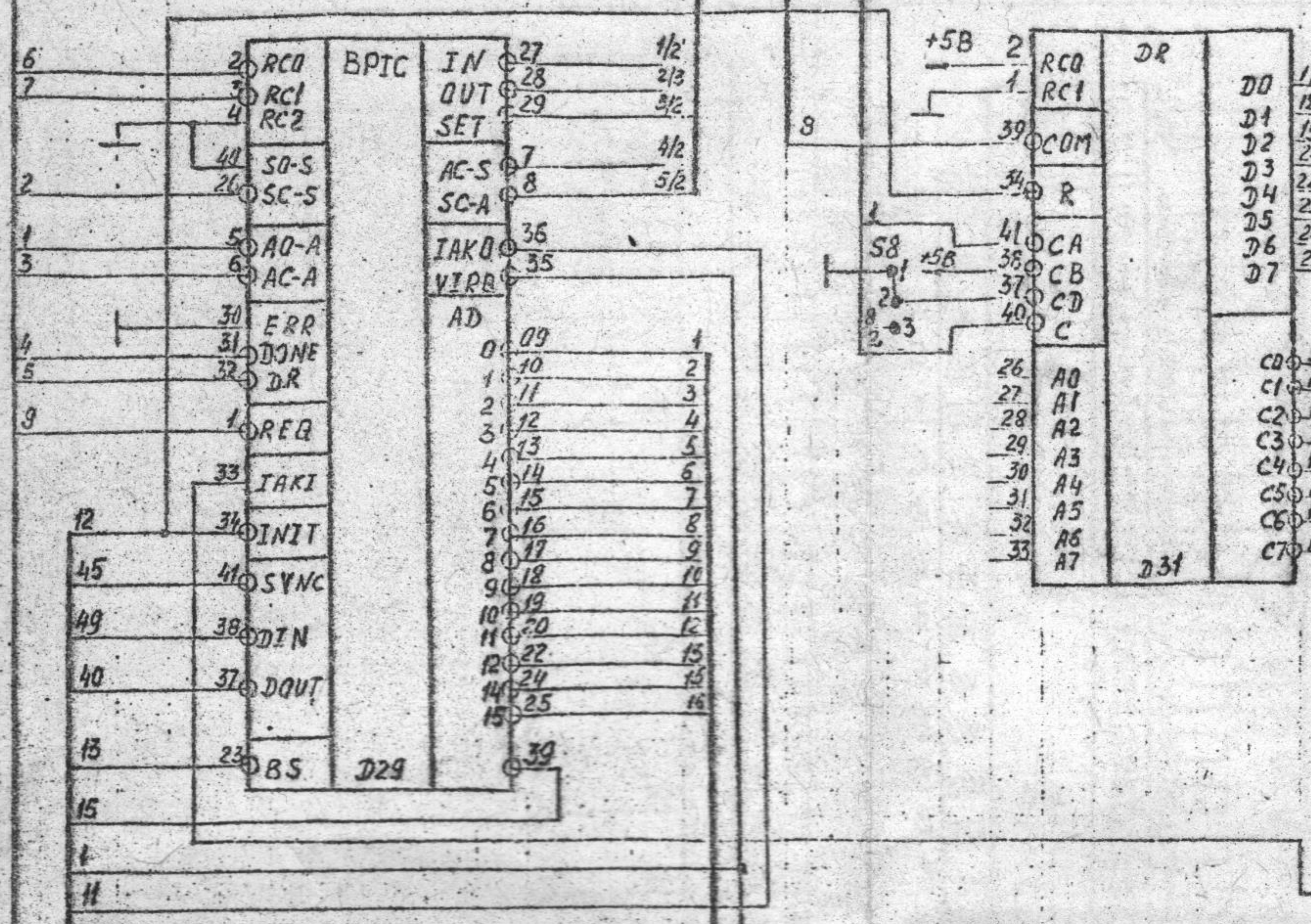
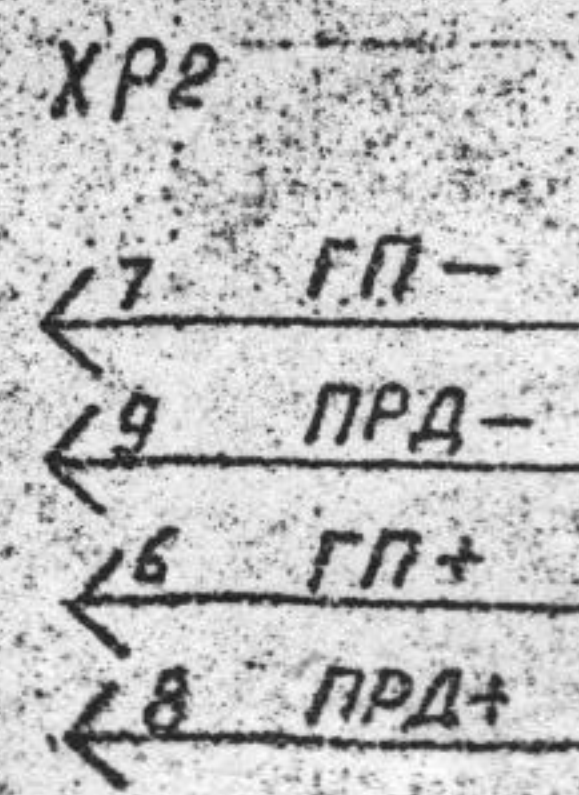

D16/1 2	*R
D17/6 3	
D16/3 4	
D14/3 5	
D14/1 6	
D15/3 7	
D17/3 8	
D4/7 9	
D15/10 10	
A11	
D17/3 2	*R
D34/6 3	
D34/5 4	
D34/4 5	
D34/3 6	
D54/27 7	
D34/28 8	
D34/17 9	
D34/23 10	
A12	

Изготовлено в Днепропетровске на заводе "Электрон" в 1967 г.

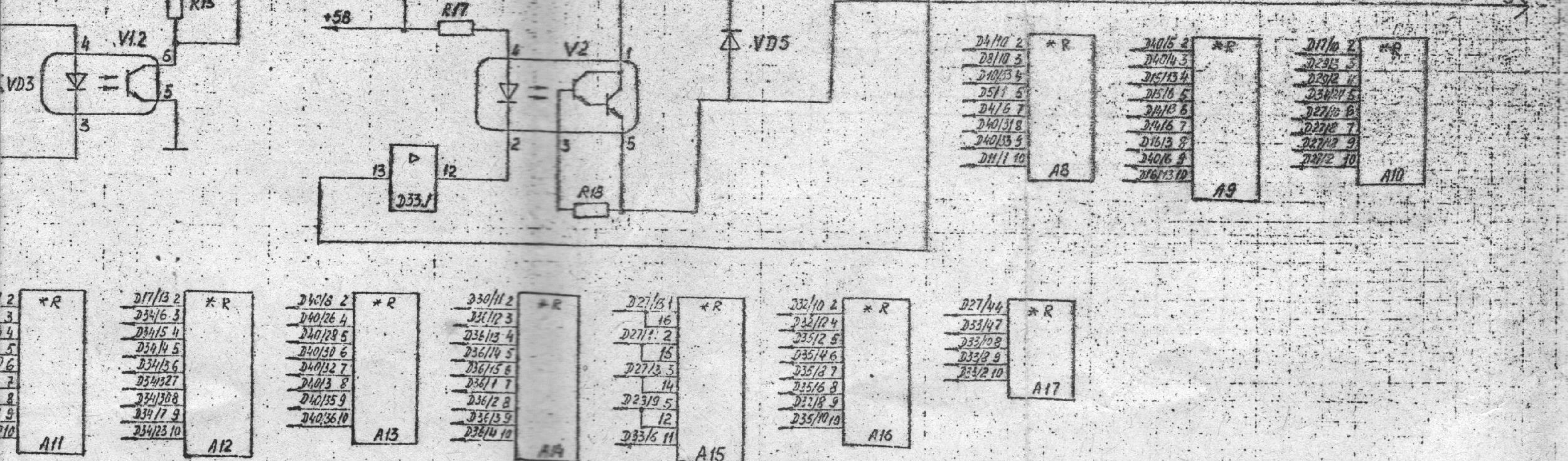
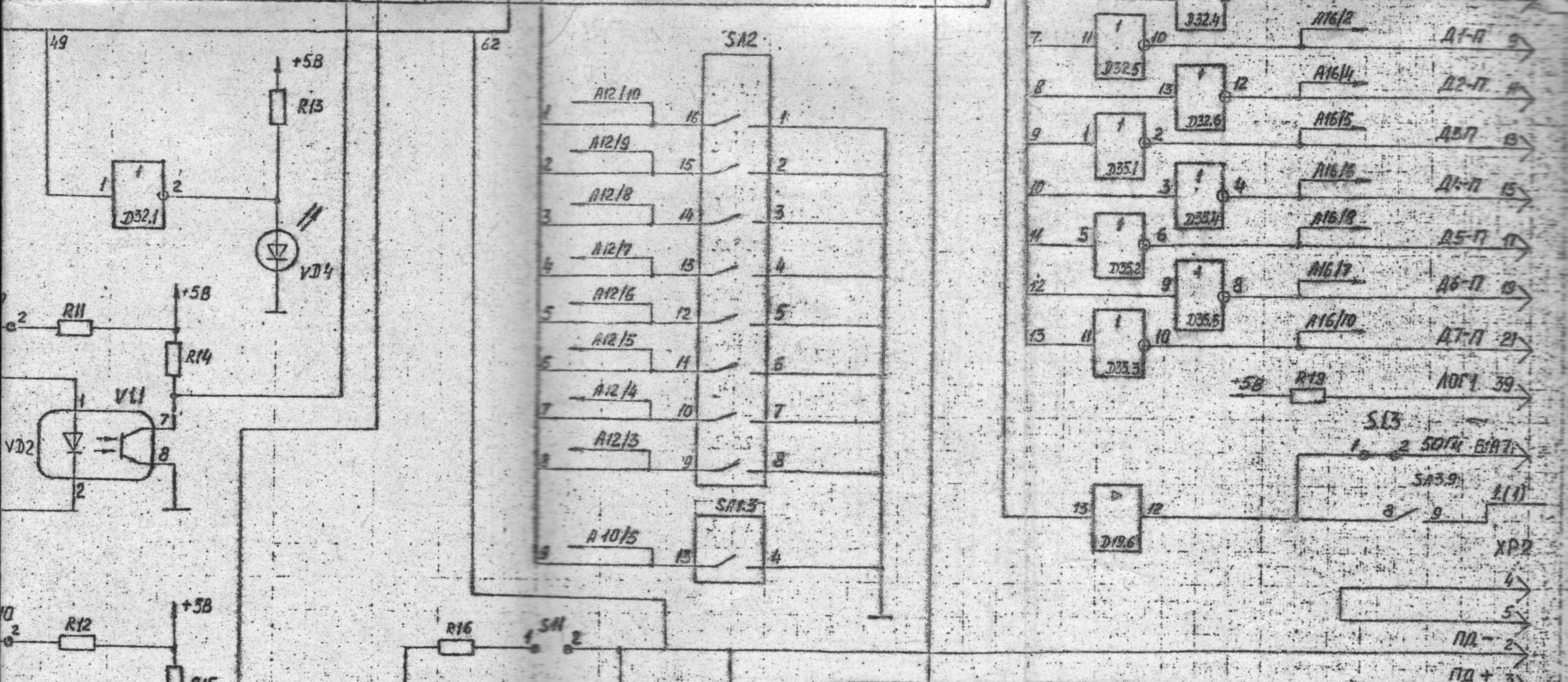
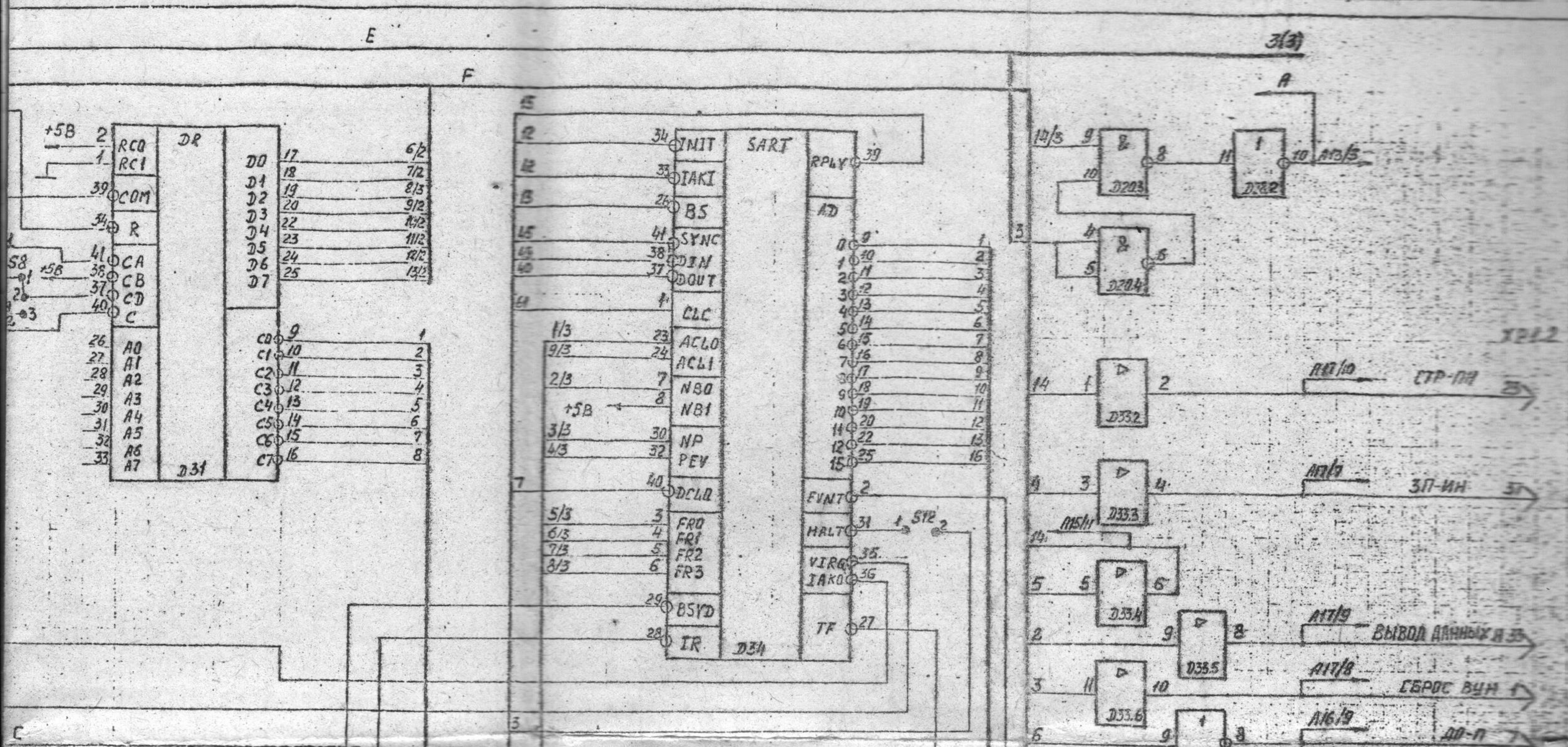

2 *R	D17/13 2 *R	D40/16 2 *R	D30/11 2 *R	D27/11 2 *R	D32/10 2 *R	D27/44 *R
3	D34/16 3	D40/26 4	D31/12 3	D27/12 2	D32/12 4	D33/47
4	D34/15 4	D40/28 5	D36/13 4	D27/13 2	D35/12 5	D33/108
5	D34/14 5	D40/30 6	D36/14 5	D27/14 3	D35/14 6	D33/29
6	D34/13 6	D40/32 7	D36/15 6	D27/15 3	D35/16 7	D33/10
7	D34/12 7	D40/34 8	D36/16 7	D27/16 3	D35/18 8	
8	D34/11 8	D40/36 9	D36/17 8	D27/17 3	D35/20 9	
9	D34/10 9	D40/38 10	D36/18 9	D27/18 3	D35/22 10	
10	D34/9 10		D36/19 10	D27/19 3		
			D36/20 11	D27/20 3		
			D36/21 12	D27/21 3		
			D36/22 13	D27/22 3		
			D36/23 14	D27/23 3		
			D36/24 15	D27/24 3		
			D36/25 16	D27/25 3		
			D36/26 17	D27/26 3		
			D36/27 18	D27/27 3		
			D36/28 19	D27/28 3		
			D36/29 20	D27/29 3		
			D36/30 21	D27/30 3		
			D36/31 22	D27/31 3		
			D36/32 23	D27/32 3		
			D36/33 24	D27/33 3		
			D36/34 25	D27/34 3		
			D36/35 26	D27/35 3		
			D36/36 27	D27/36 3		
			D36/37 28	D27/37 3		
			D36/38 29	D27/38 3		
			D36/39 30	D27/39 3		
			D36/40 31	D27/40 3		
			D36/41 32	D27/41 3		
			D36/42 33	D27/42 3		
			D36/43 34	D27/43 3		
			D36/44 35	D27/44 3		
			D36/45 36	D27/45 3		
			D36/46 37	D27/46 3		
			D36/47 38	D27/47 3		
			D36/48 39	D27/48 3		
			D36/49 40	D27/49 3		
			D36/50 41	D27/50 3		
			D36/51 42	D27/51 3		
			D36/52 43	D27/52 3		
			D36/53 44	D27/53 3		
			D36/54 45	D27/54 3		
			D36/55 46	D27/55 3		
			D36/56 47	D27/56 3		
			D36/57 48	D27/57 3		
			D36/58 49	D27/58 3		
			D36/59 50	D27/59 3		
			D36/60 51	D27/60 3		
			D36/61 52	D27/61 3		
			D36/62 53	D27/62 3		
			D36/63 54	D27/63 3		
			D36/64 55	D27/64 3		
			D36/65 56	D27/65 3		
			D36/66 57	D27/66 3		
			D36/67 58	D27/67 3		
			D36/68 59	D27/68 3		
			D36/69 60	D27/69 3		
			D36/70 61	D27/70 3		
			D36/71 62	D27/71 3		
			D36/72 63	D27/72 3		
			D36/73 64	D27/73 3		
			D36/74 65	D27/74 3		
			D36/75 66	D27/75 3		
			D36/76 67	D27/76 3		
			D36/77 68	D27/77 3		
			D36/78 69	D27/78 3		
			D36/79 70	D27/79 3		
			D36/80 71	D27/80 3		
			D36/81 72	D27/81 3		
			D36/82 73	D27/82 3		
			D36/83 74	D27/83 3		
			D36/84 75	D27/84 3		
			D36/85 76	D27/85 3		
			D36/86 77	D27/86 3		
			D36/87 78	D27/87 3		
			D36/88 79	D27/88 3		
			D36/89 80	D27/89 3		
			D36/90 81	D27/90 3		
			D36/91 82	D27/91 3		
			D36/92 83	D27/92 3		
			D36/93 84	D27/93 3		
			D36/94 85	D27/94 3		
			D36/95 86	D27/95 3		
			D36/96 87	D27/96 3		
			D36/97 88	D27/97 3		
			D36/98 89	D27/98 3		
			D36/99 90	D27/99 3		
			D36/100 91	D27/100 3		

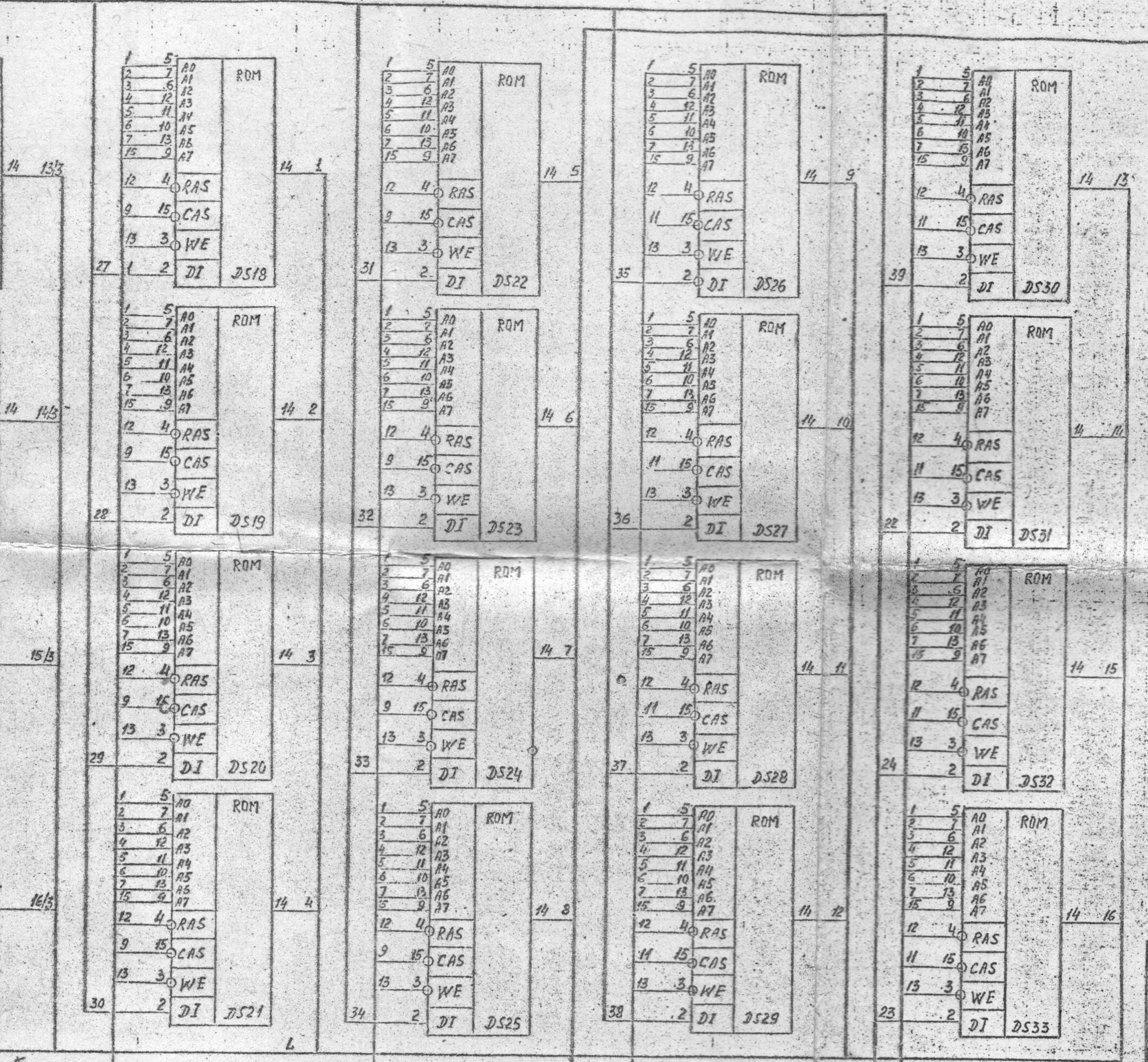

- 1 A13/4
- 2 A5/9
- 3 A13/5
- 4 A5/8
- 5 A13/6
- 6 A8/5
- 7 A13/7
- 8 A13/9
- 9 A13/8
- 10 A9/3
- 11 A9/2
- 12 A9/9
- 13 A11/2
- 14 A13/2
- 15 A13/2
- 16 A13/10

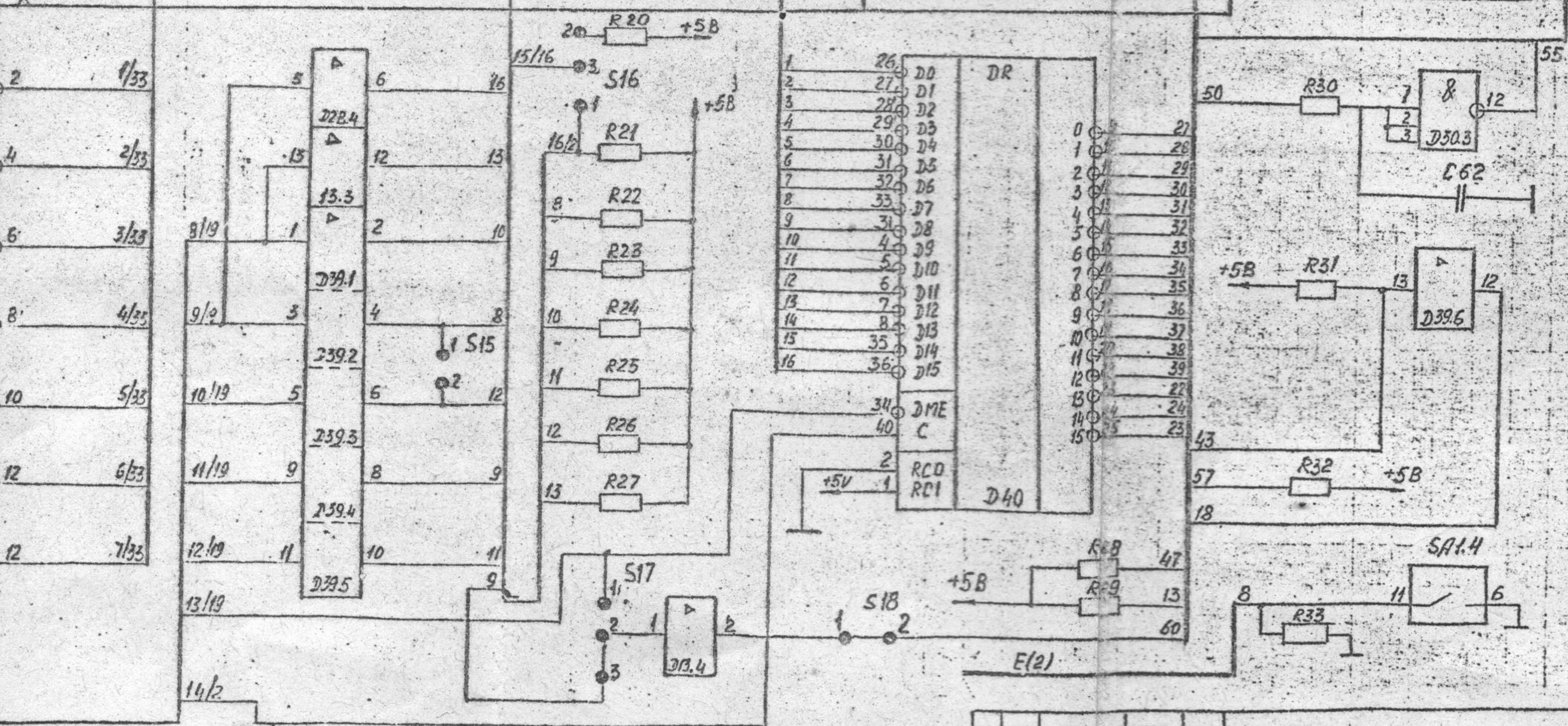

ИЛ 43.059.064-0133

7.1(1)

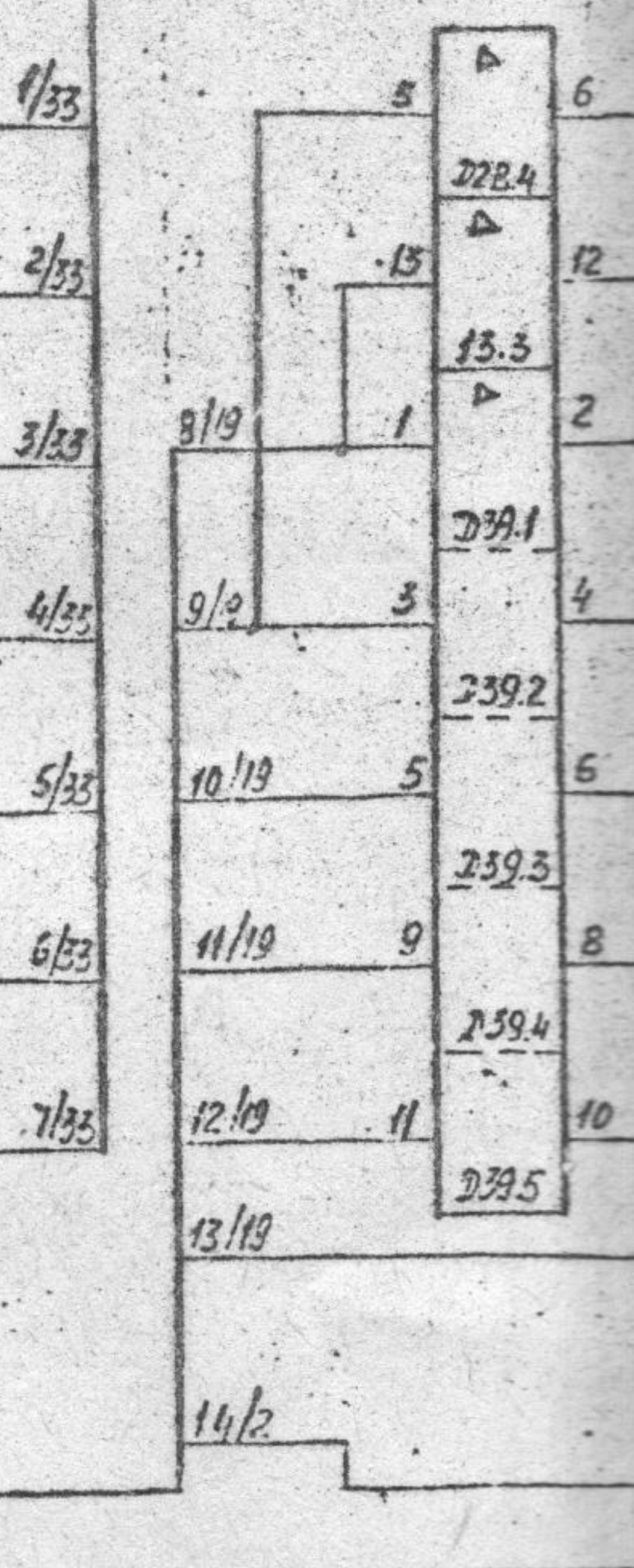
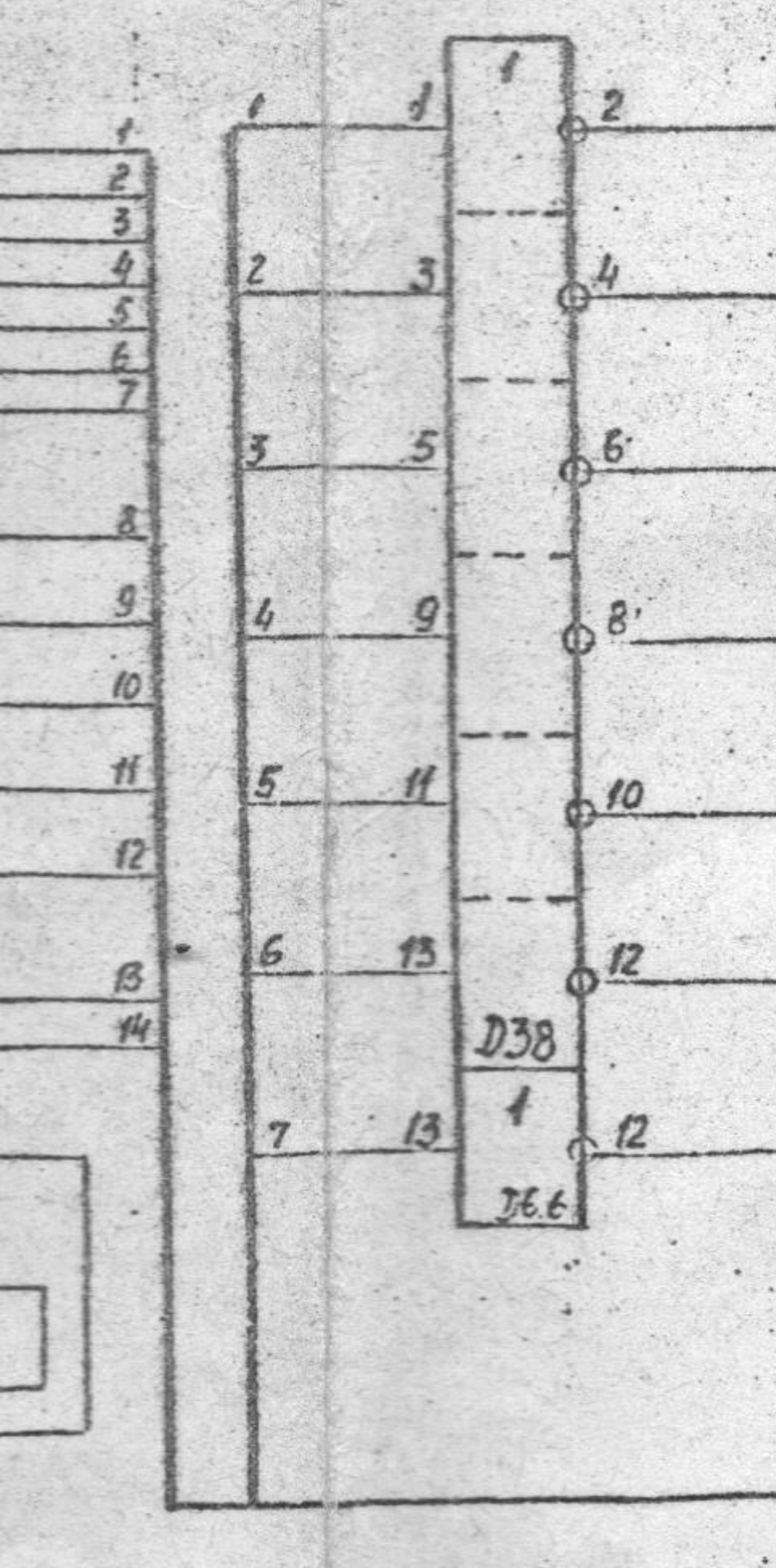
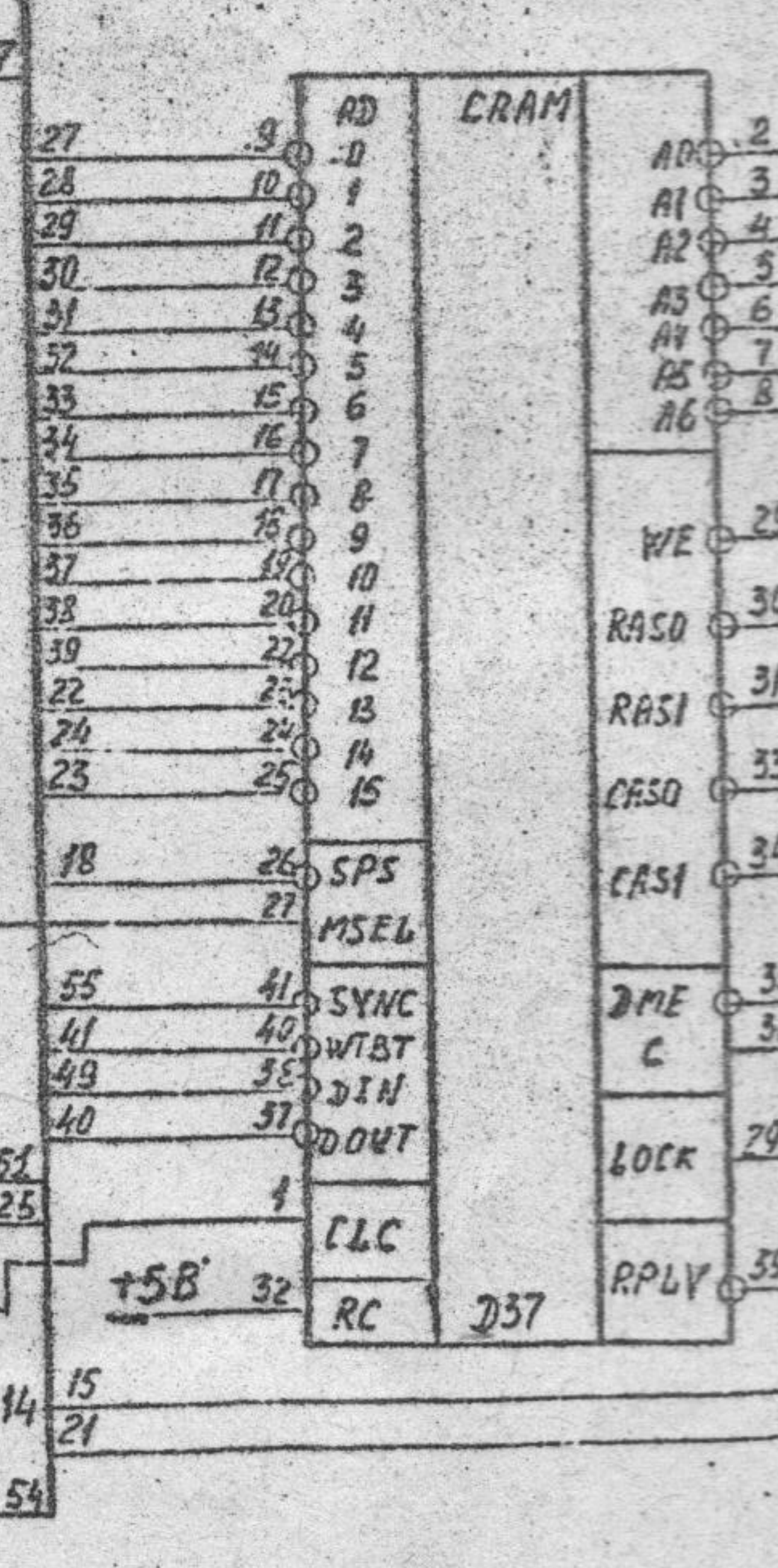
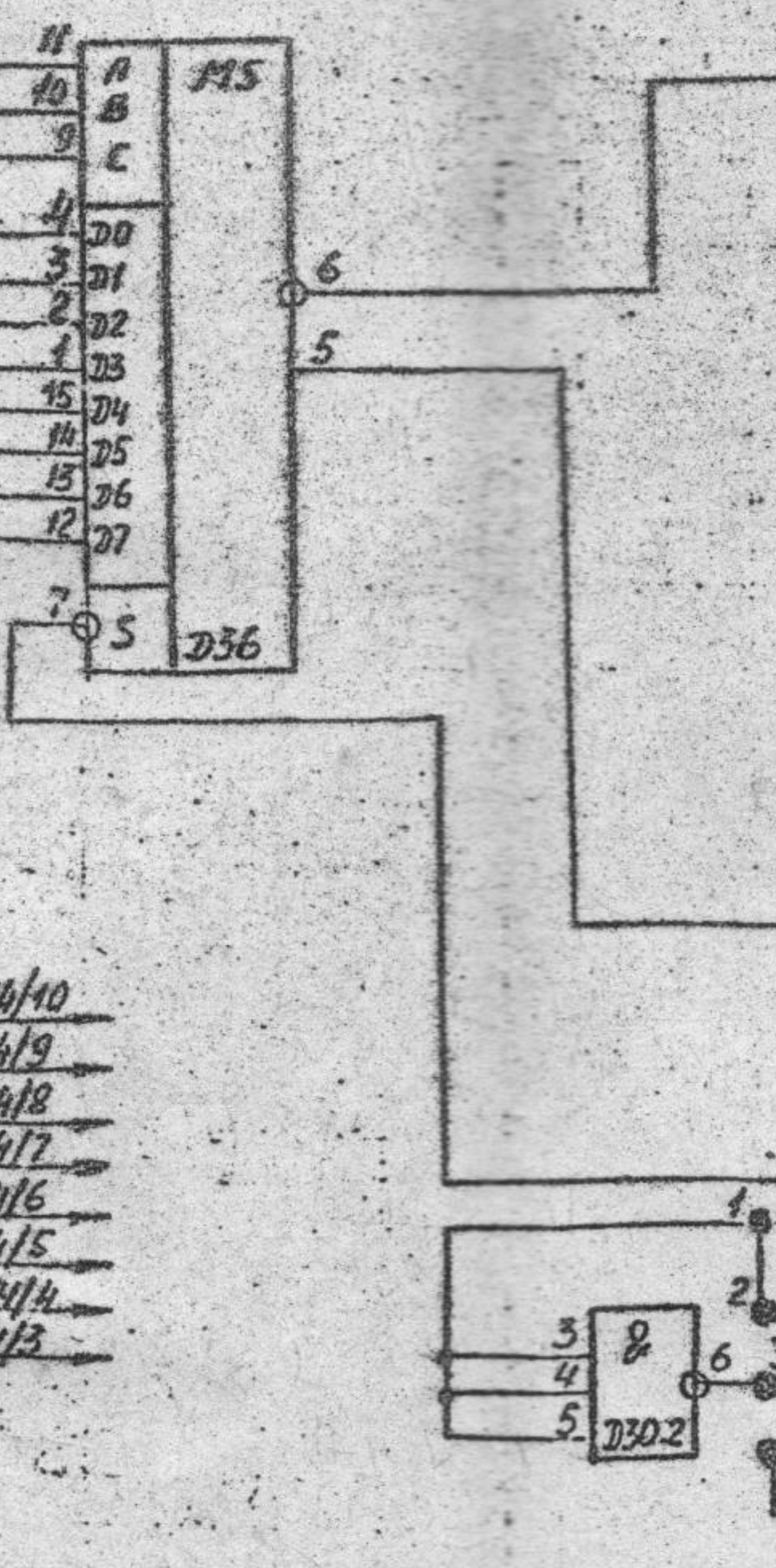
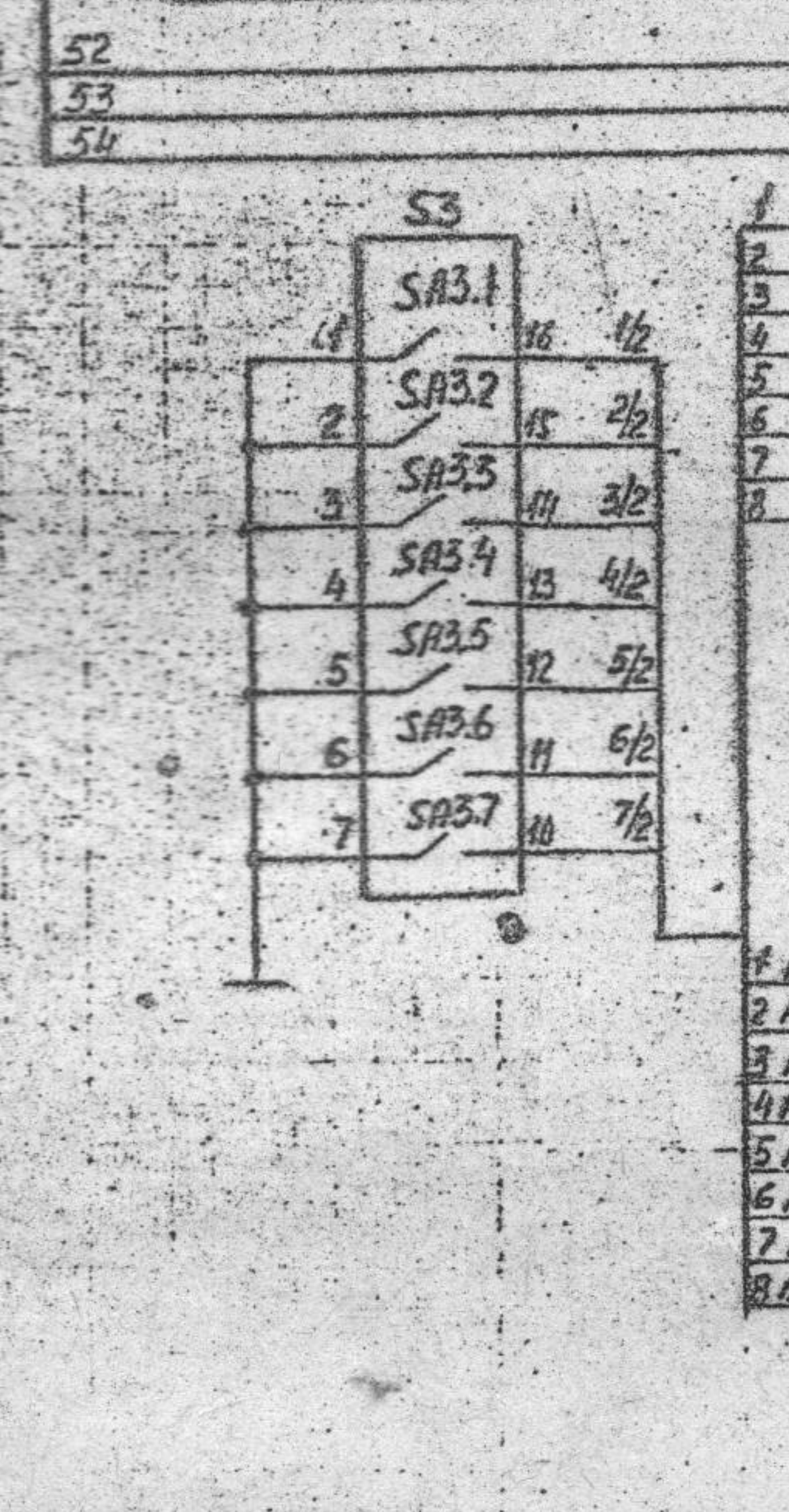
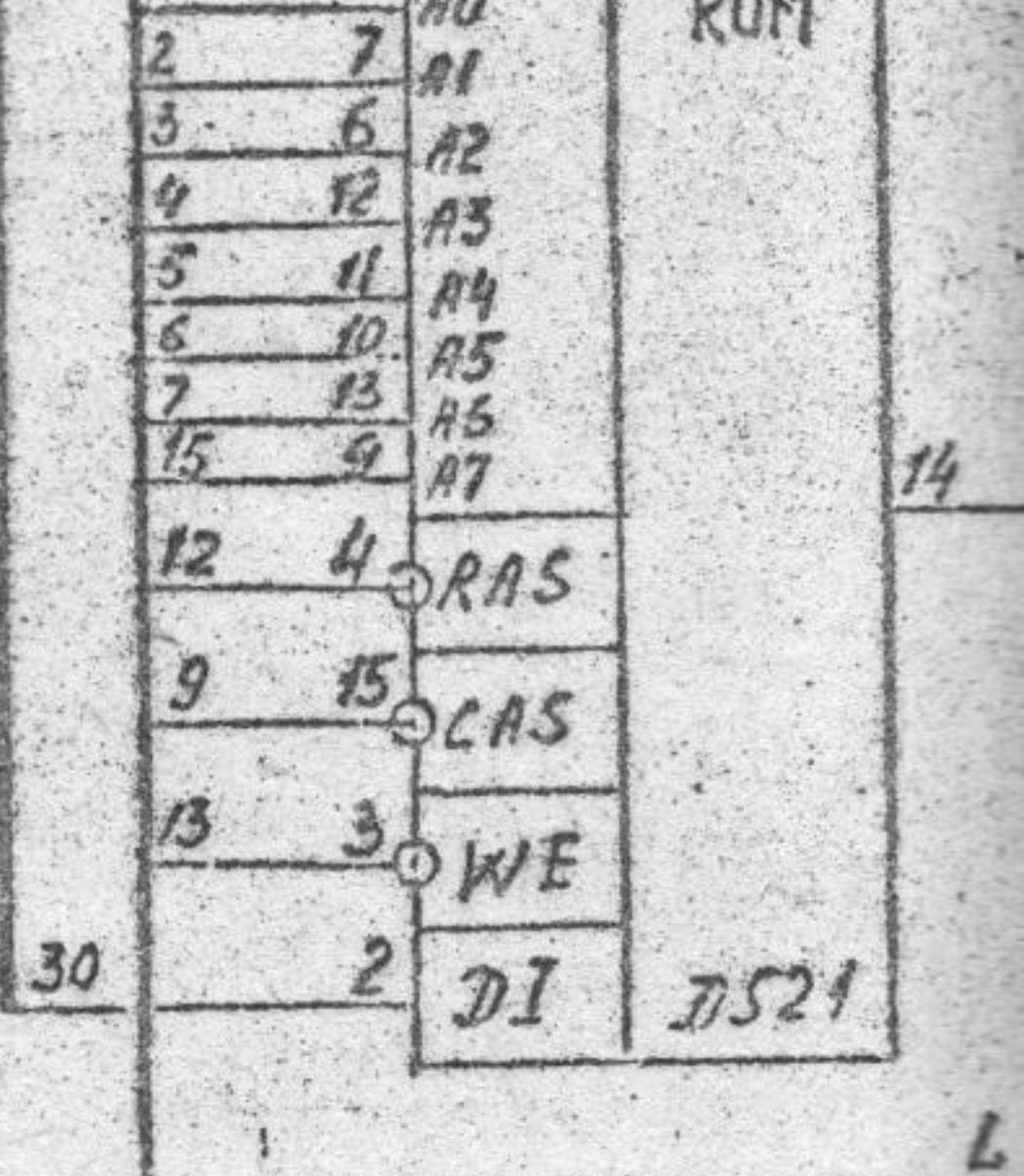
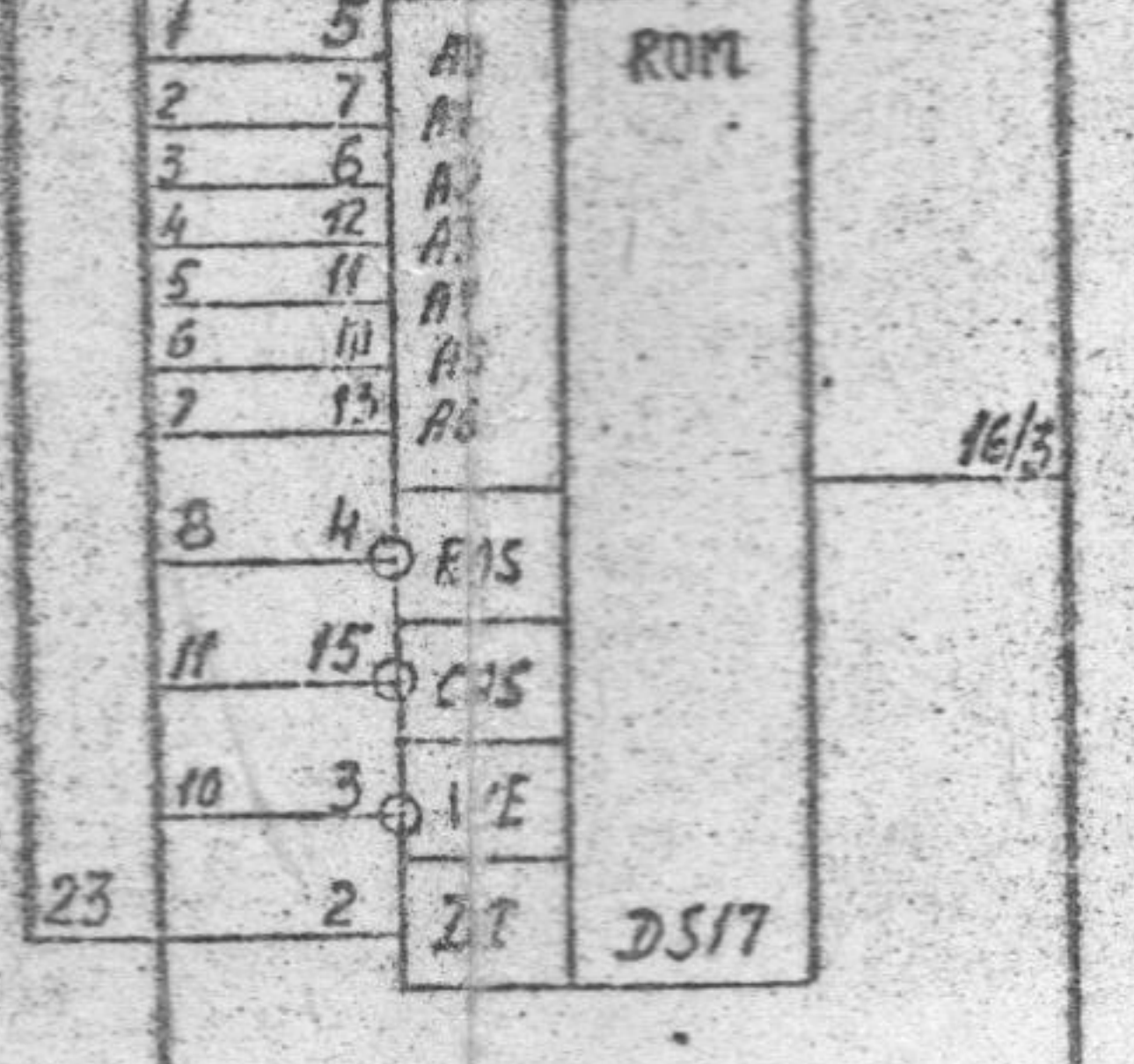
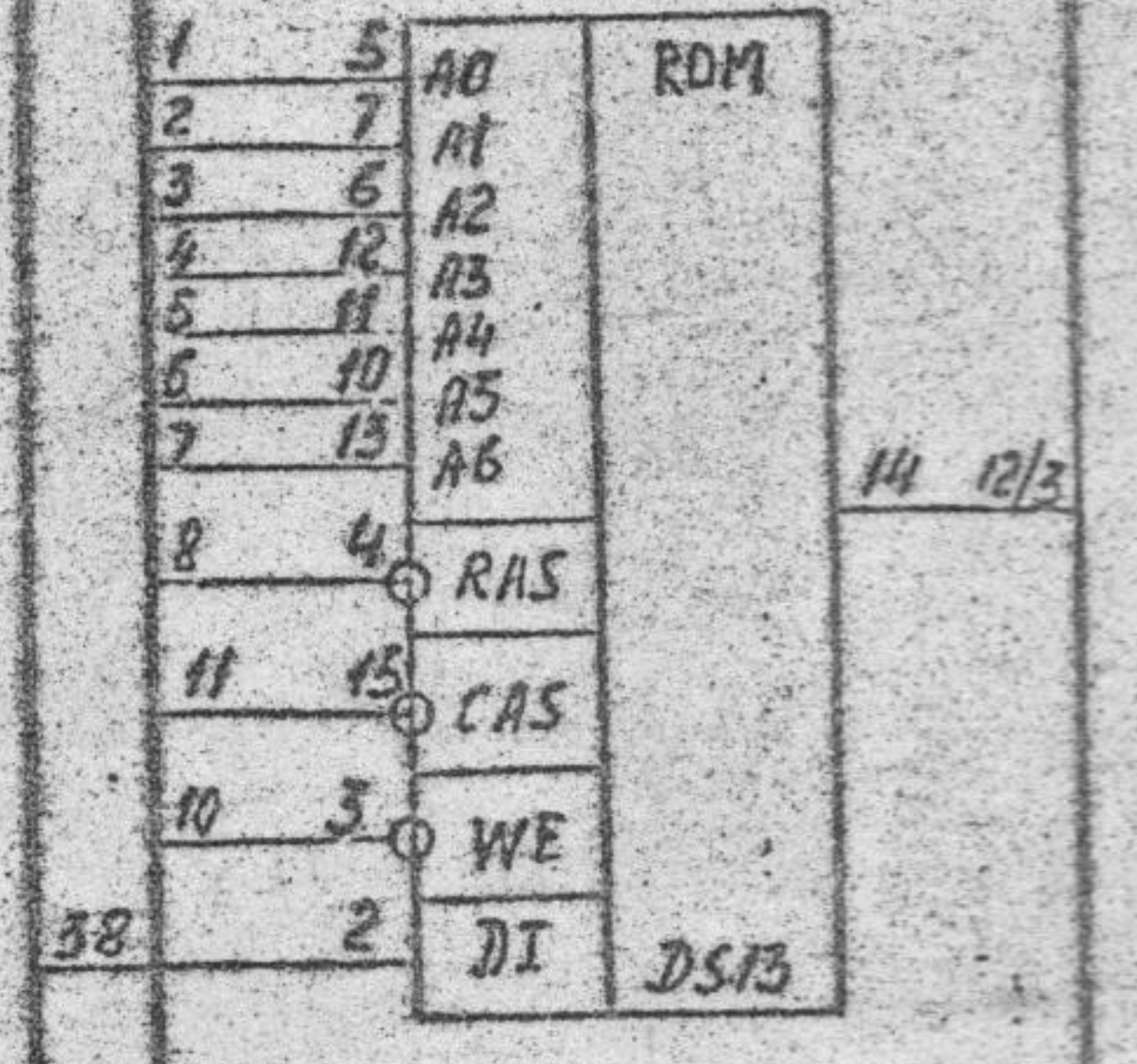
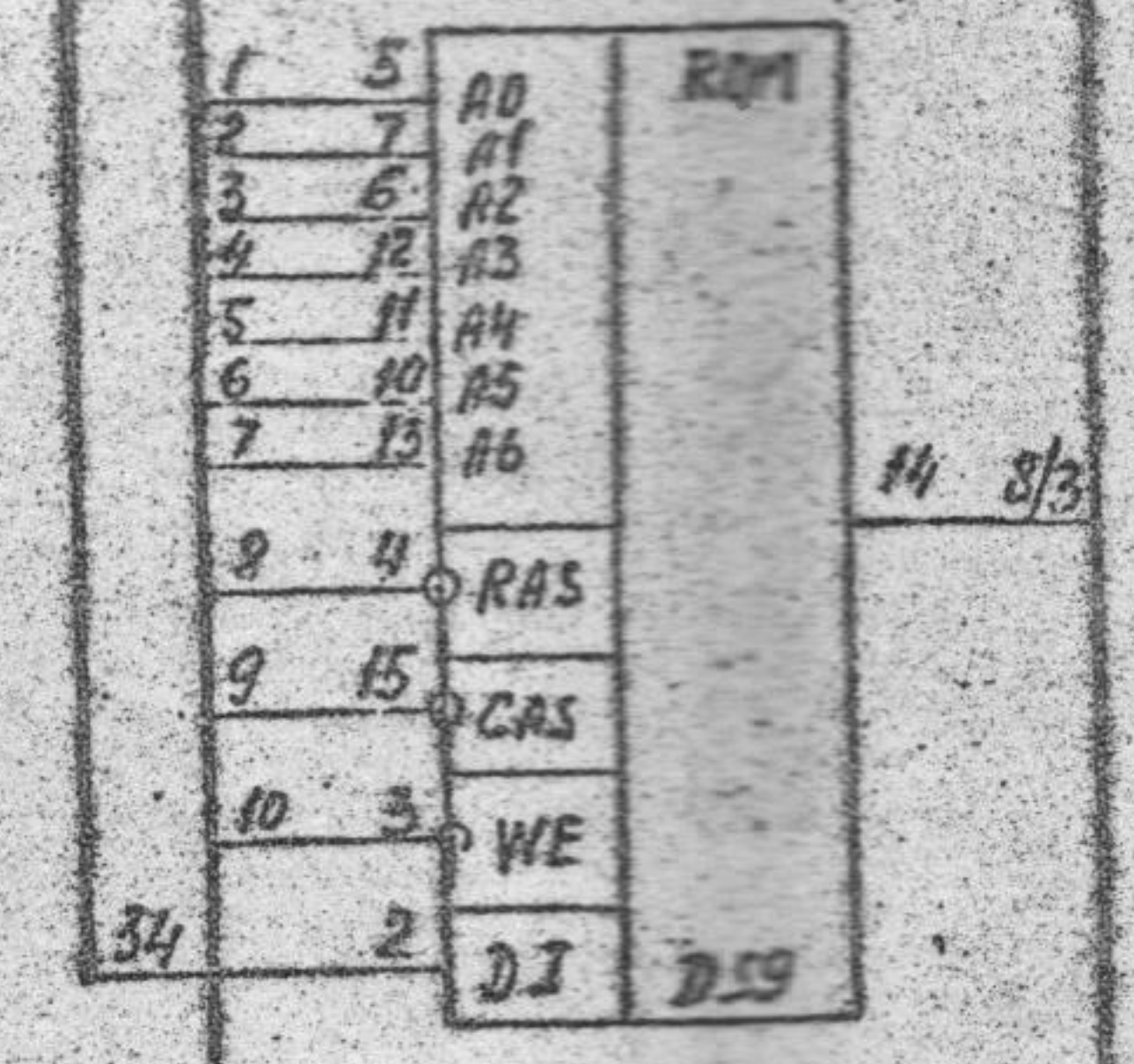
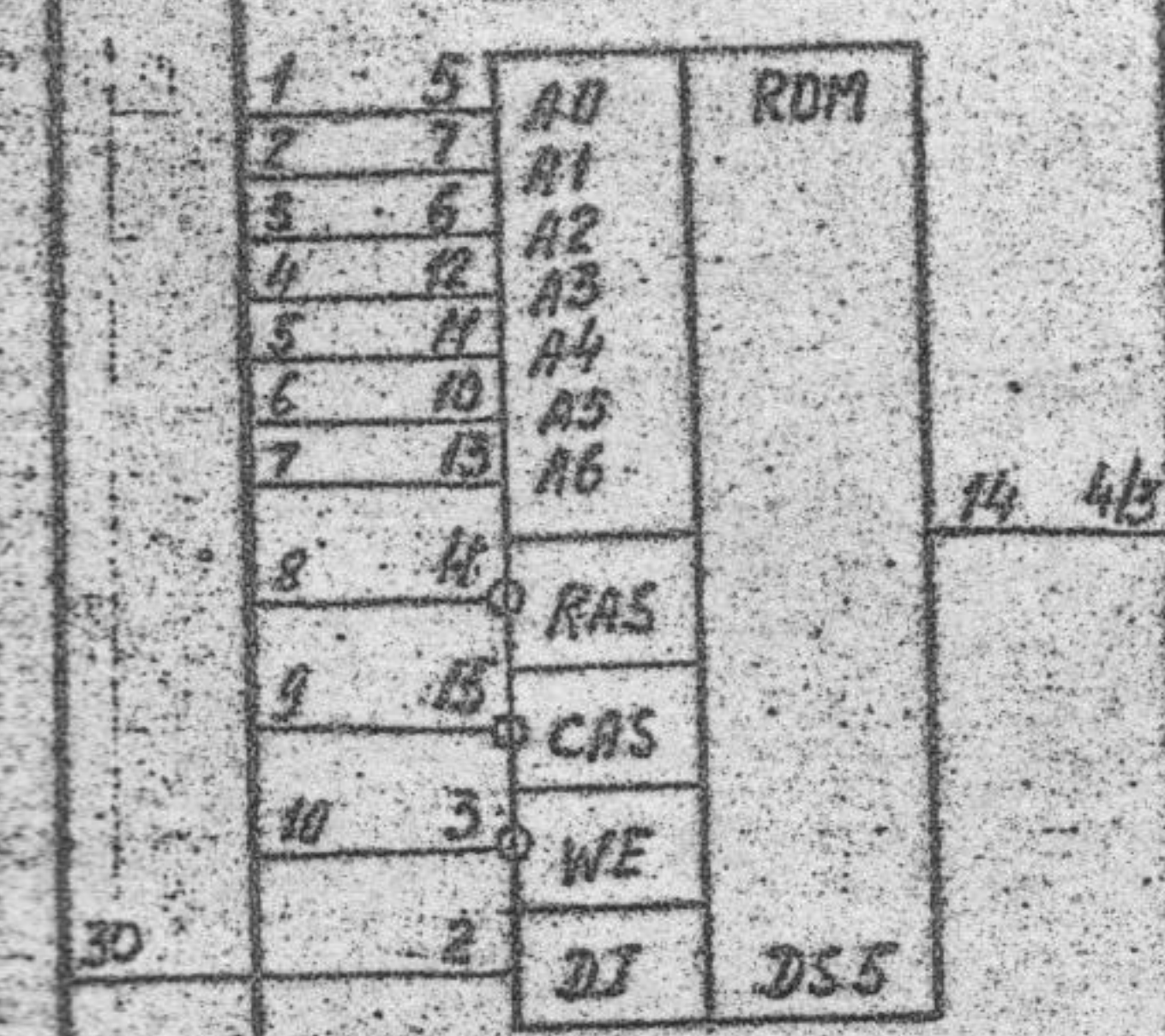
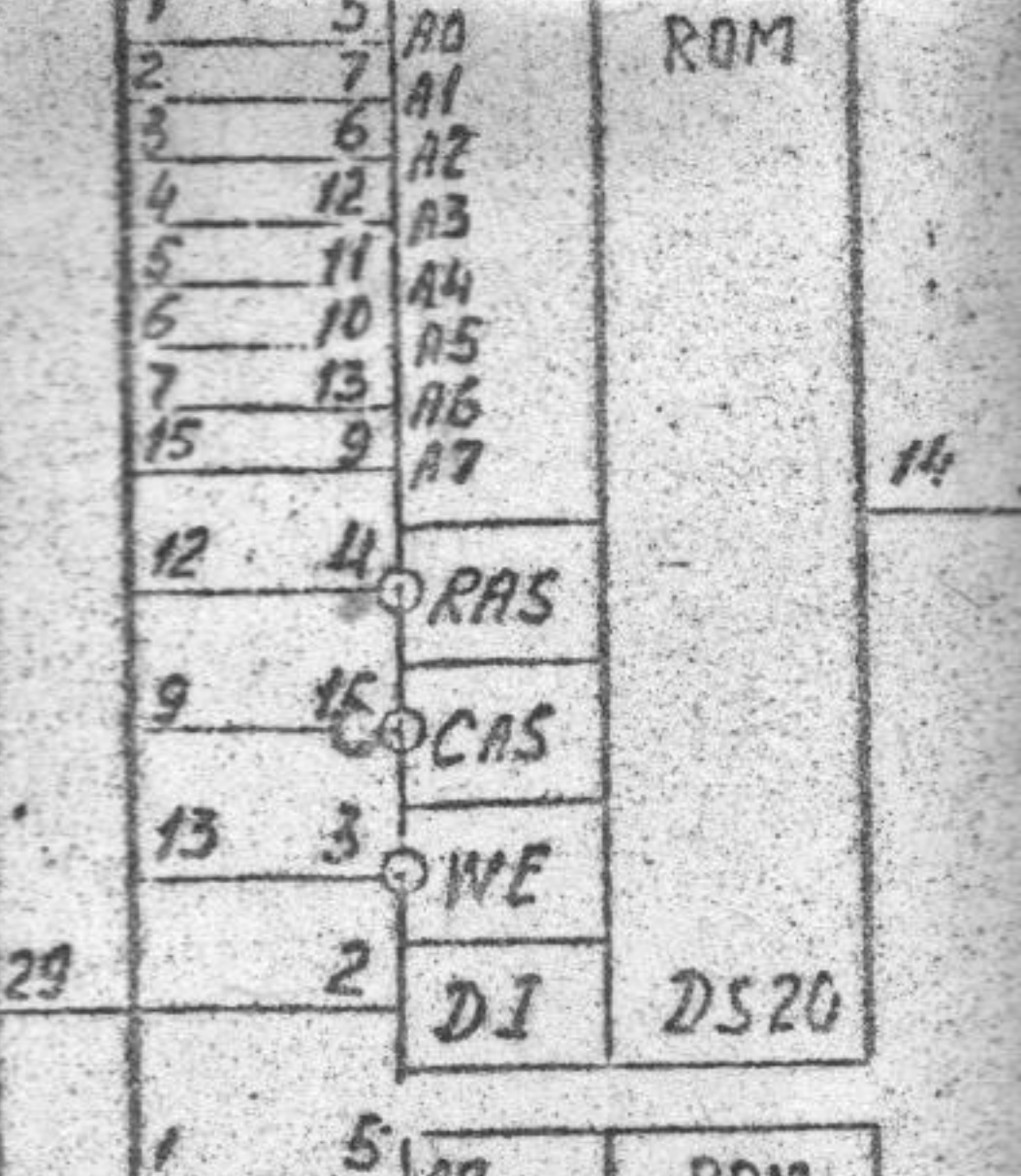
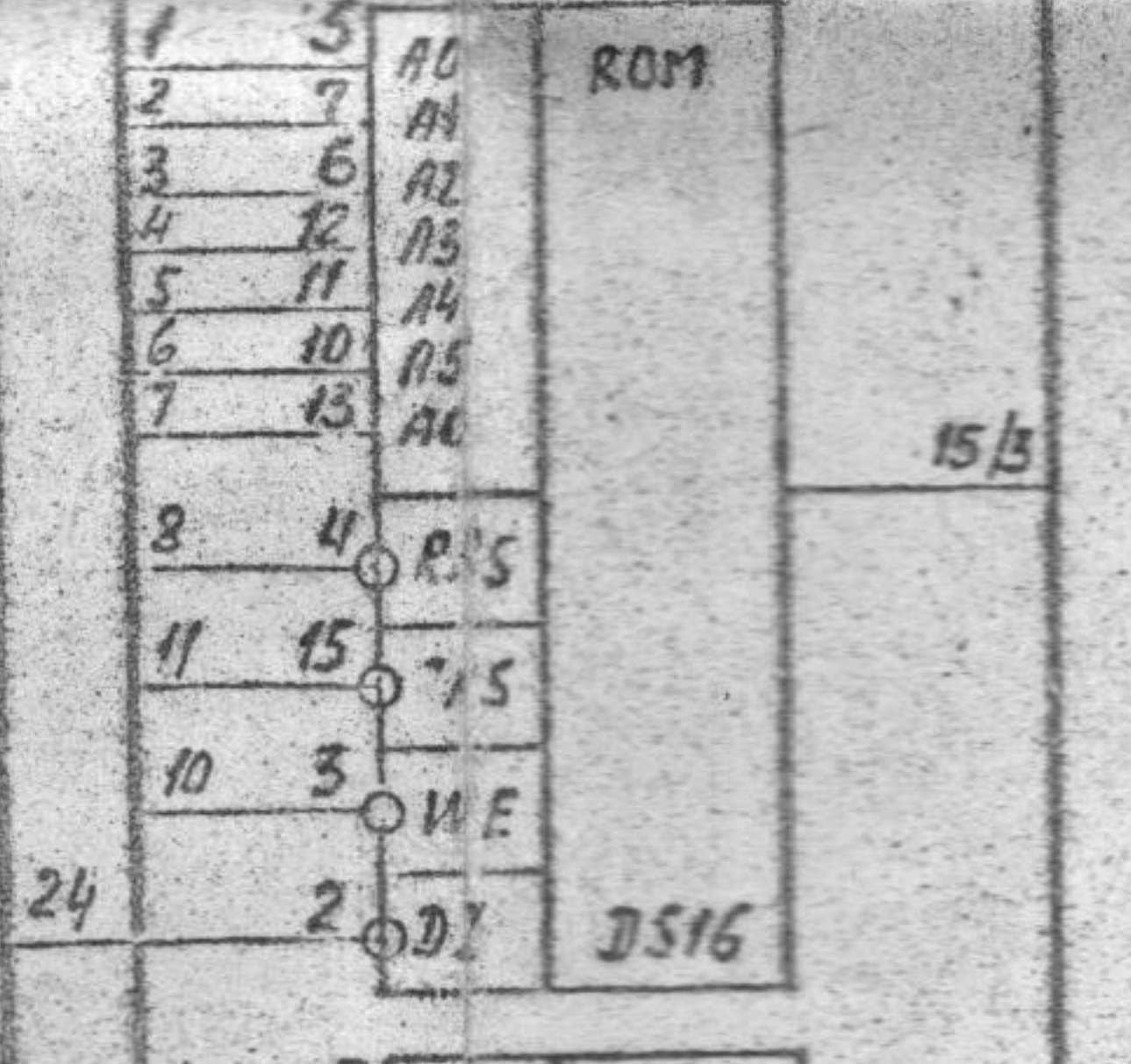
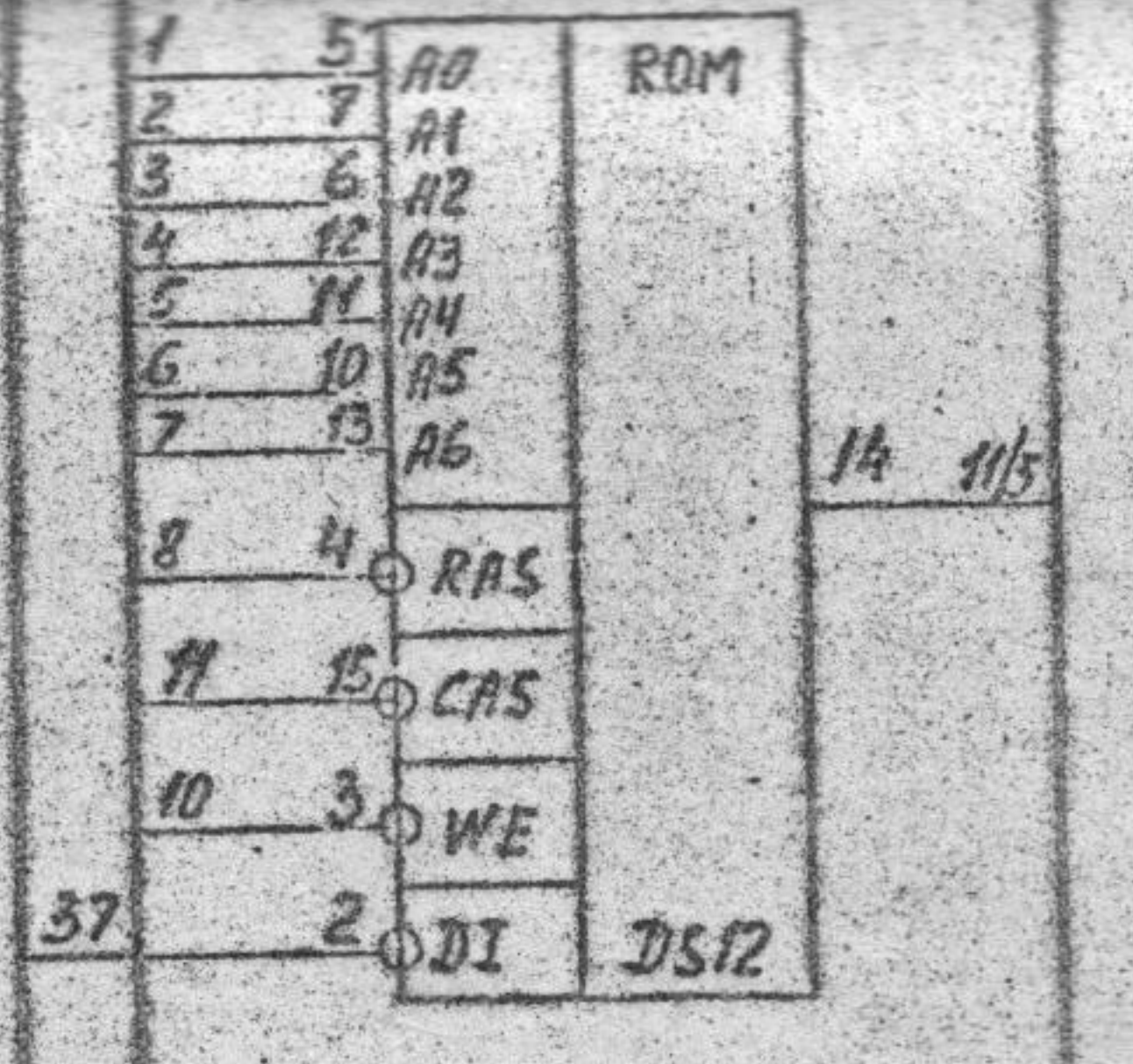
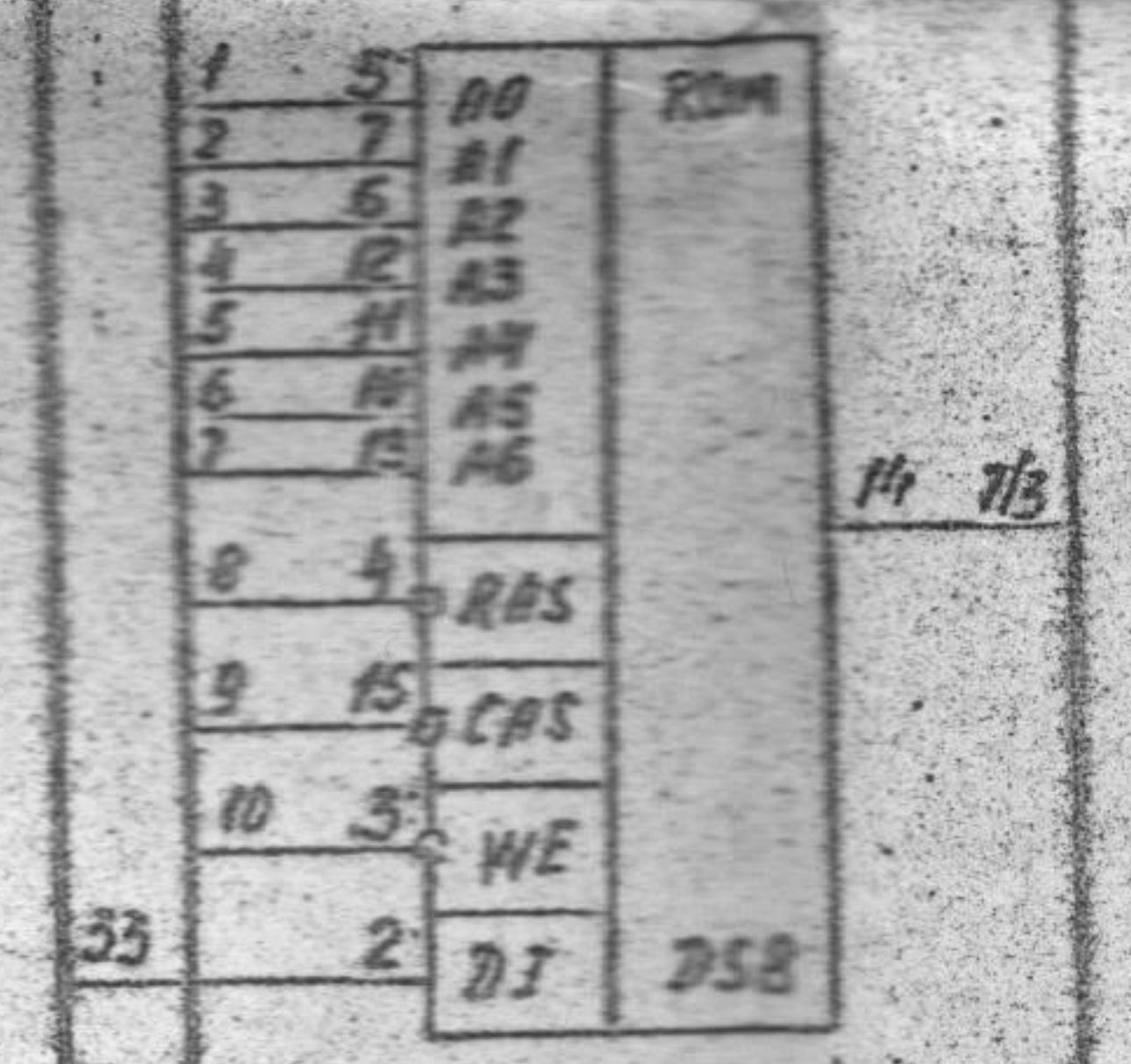
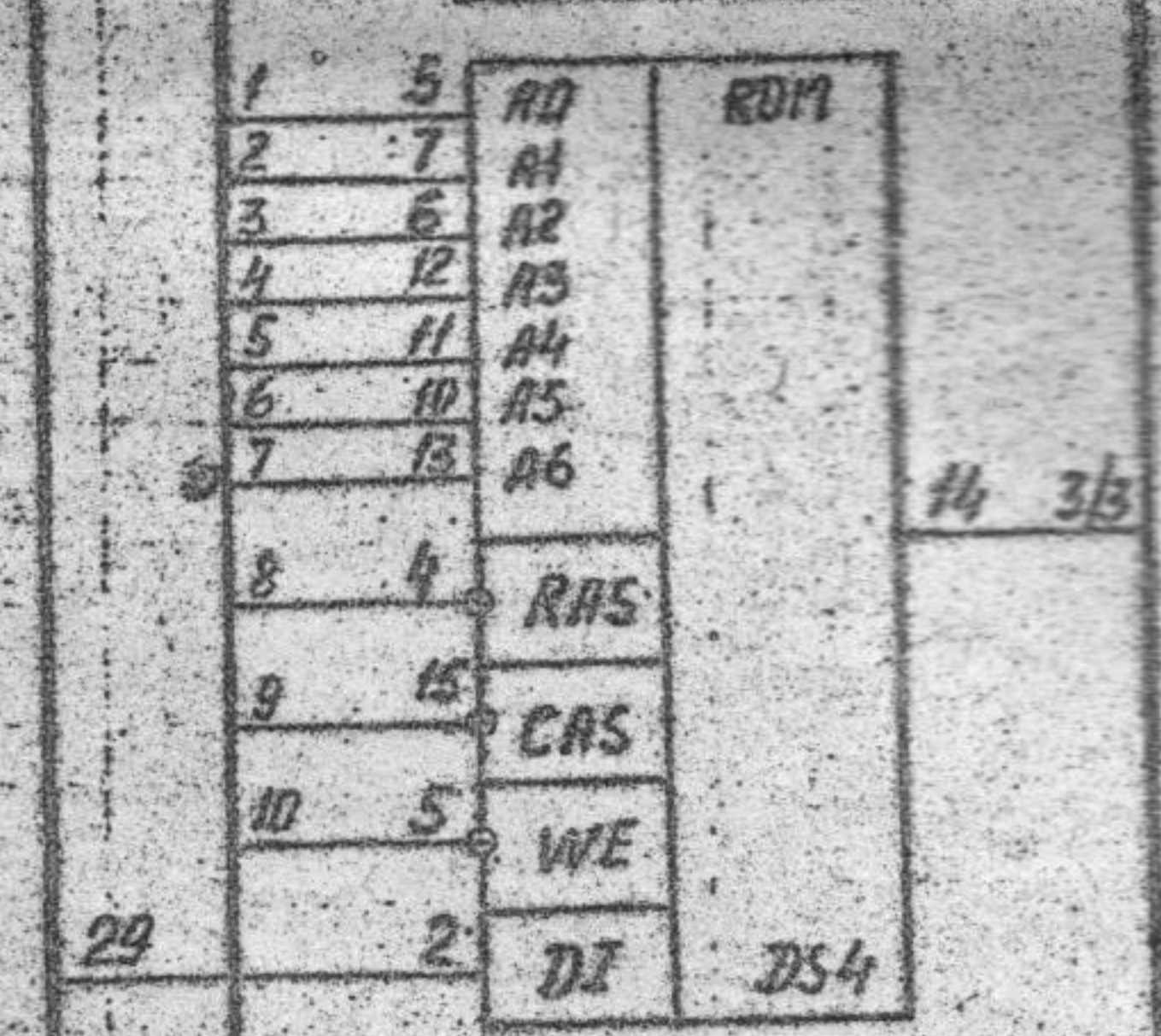
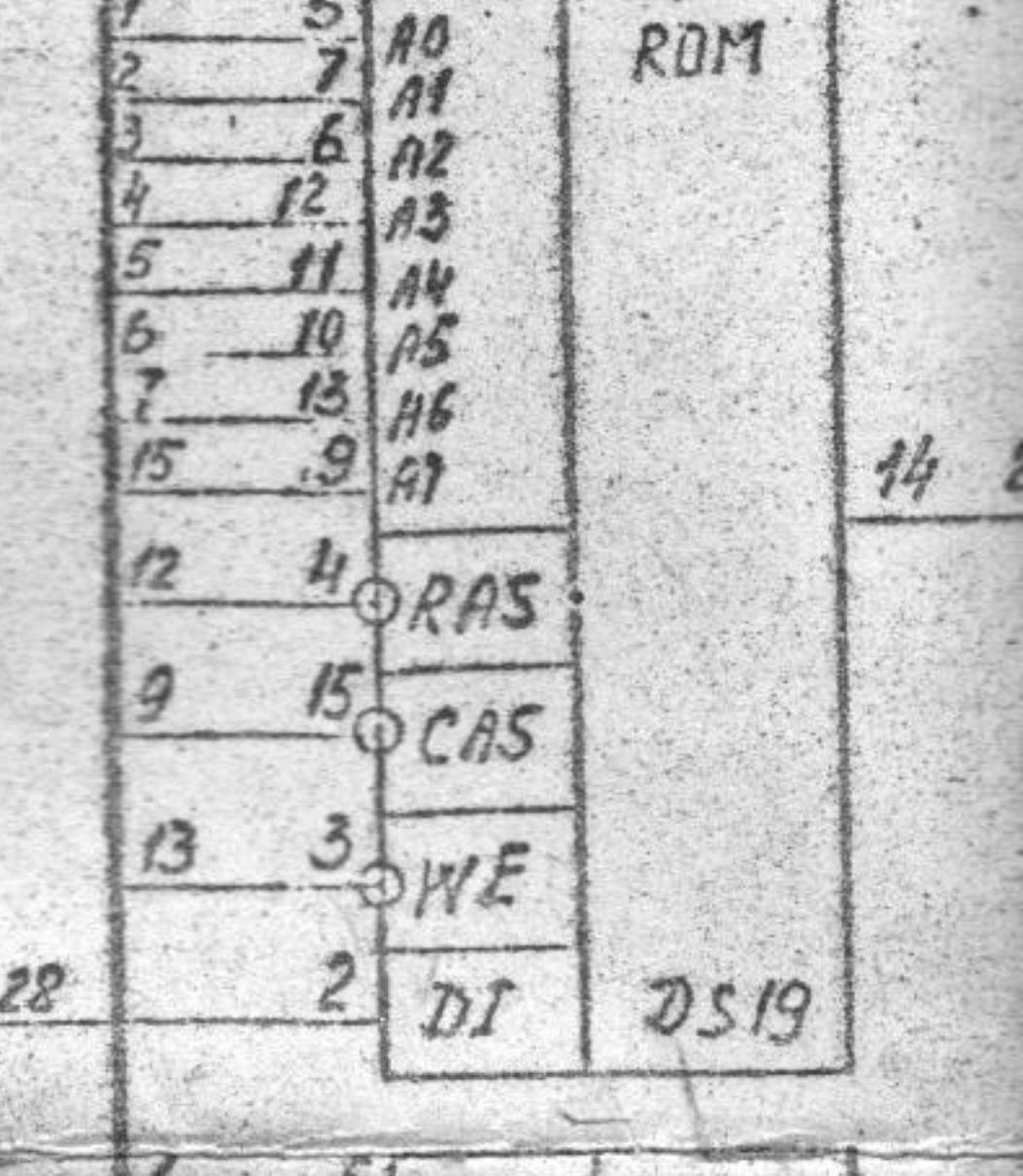
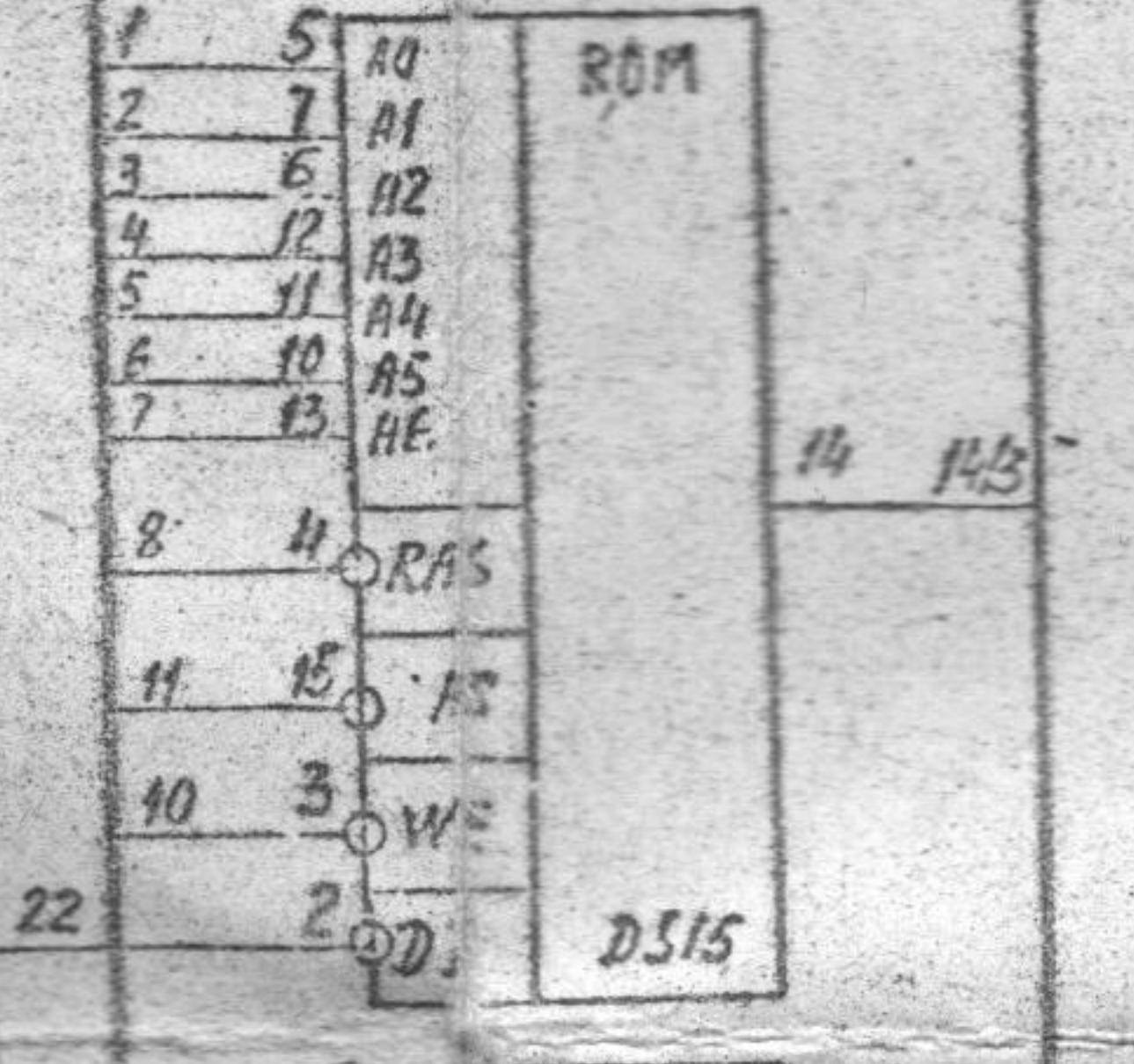
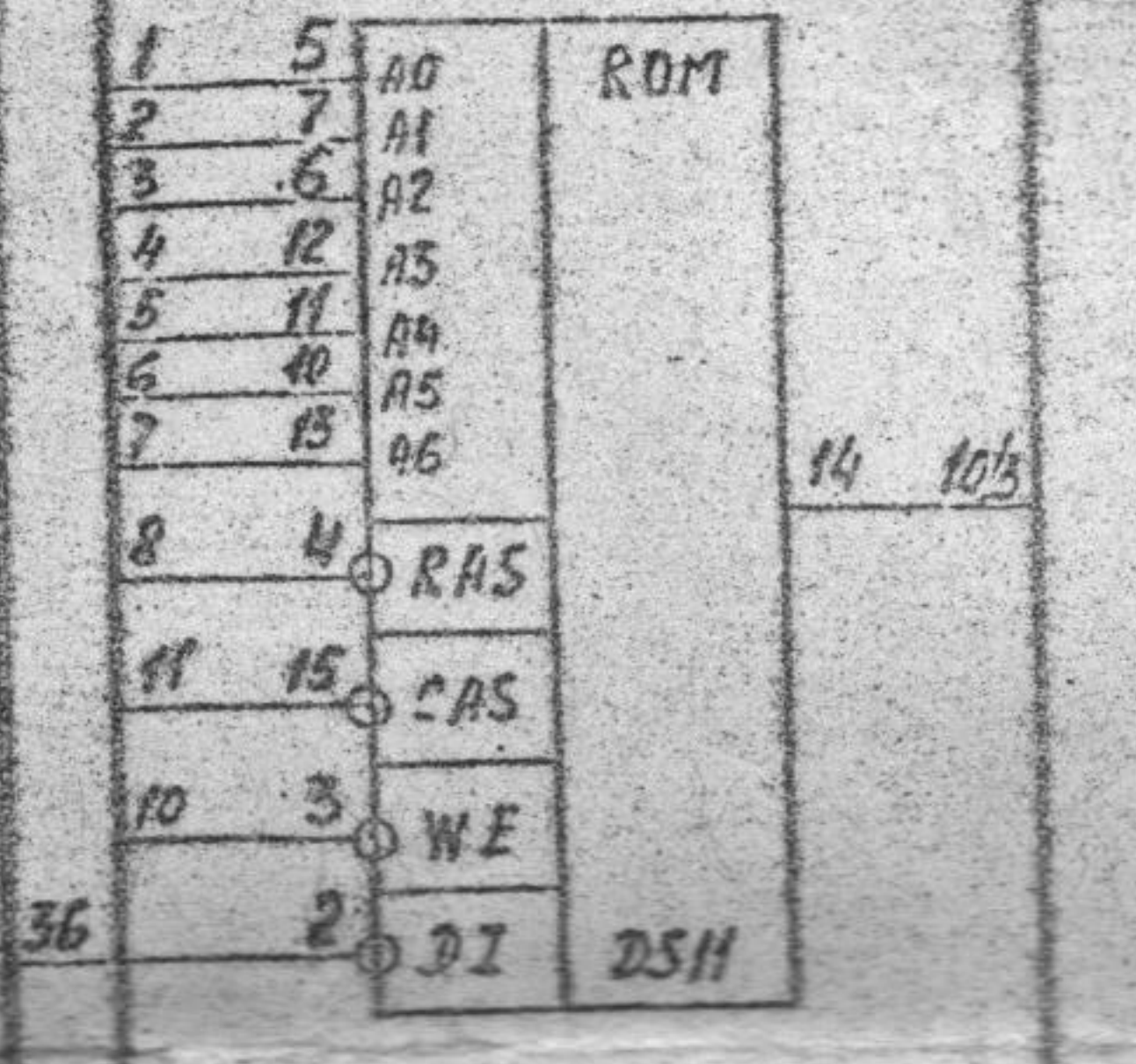
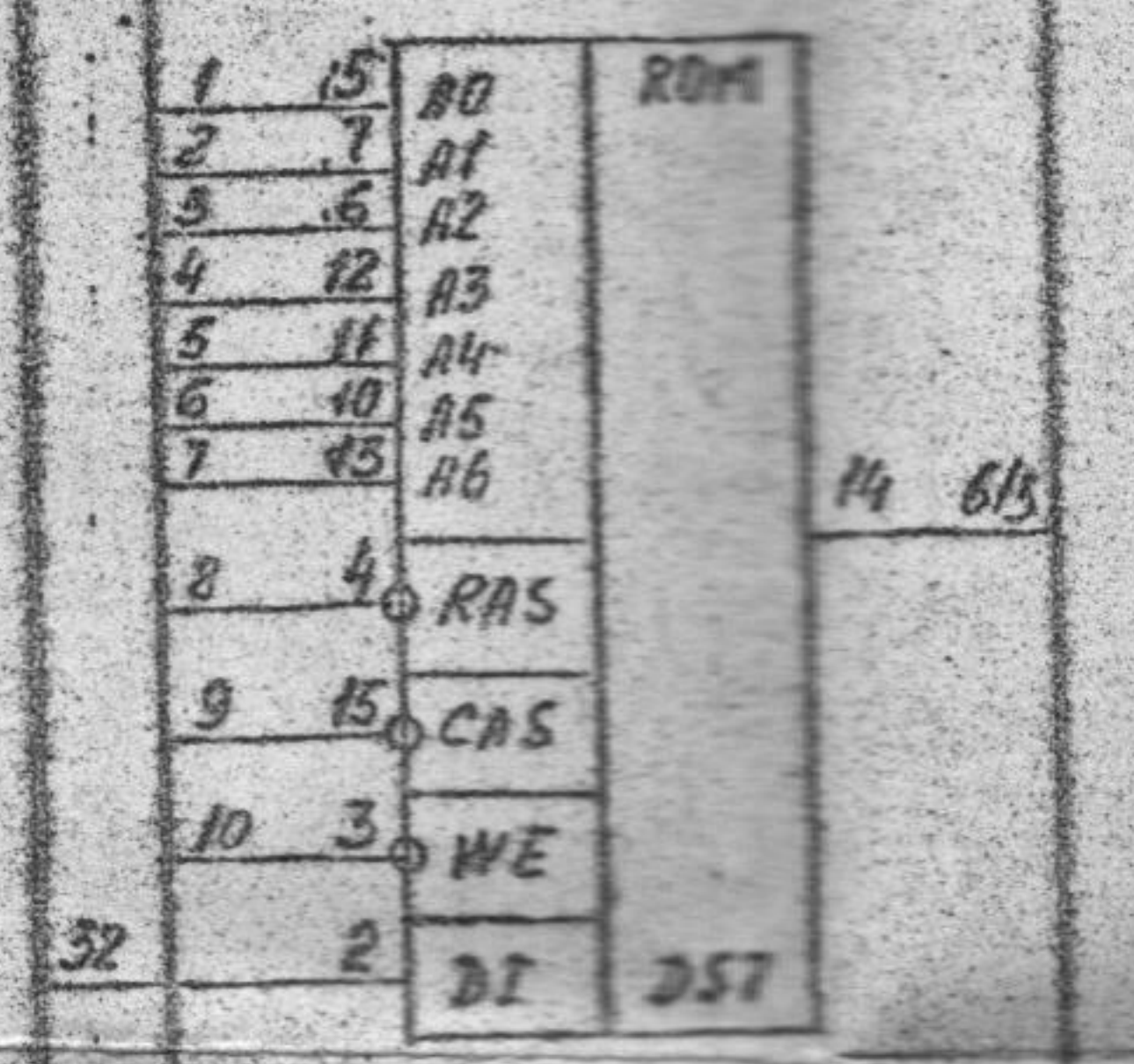
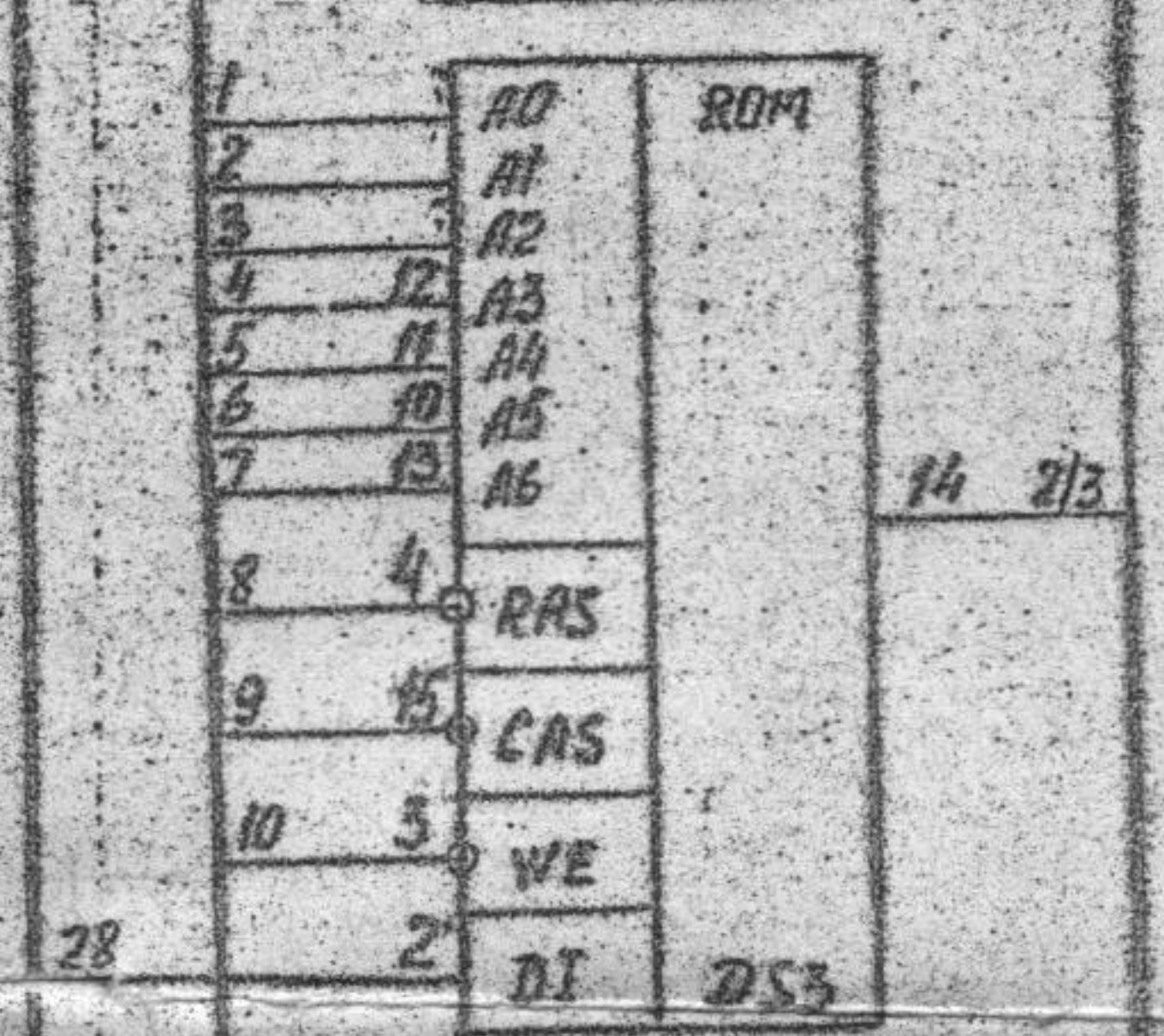
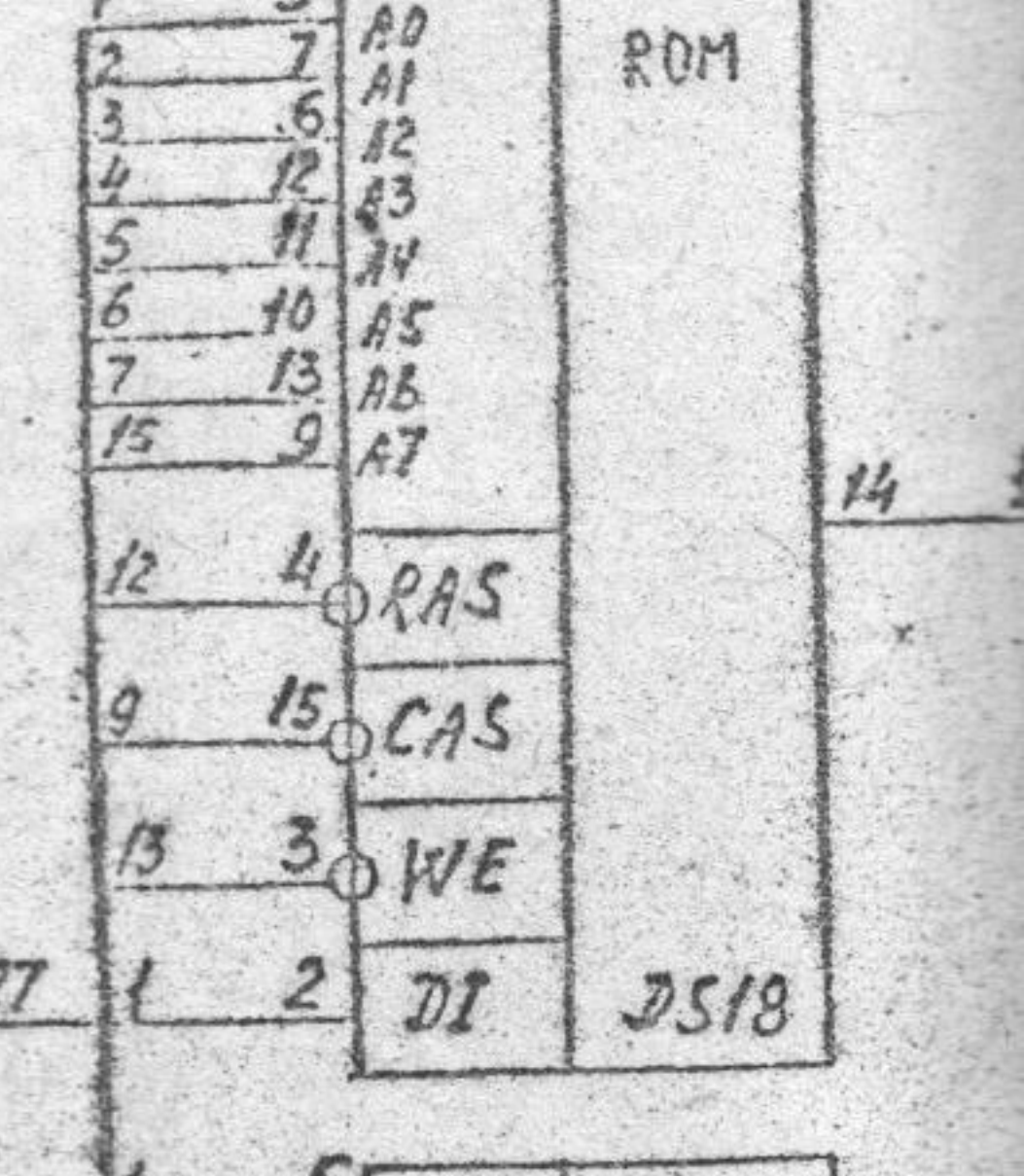
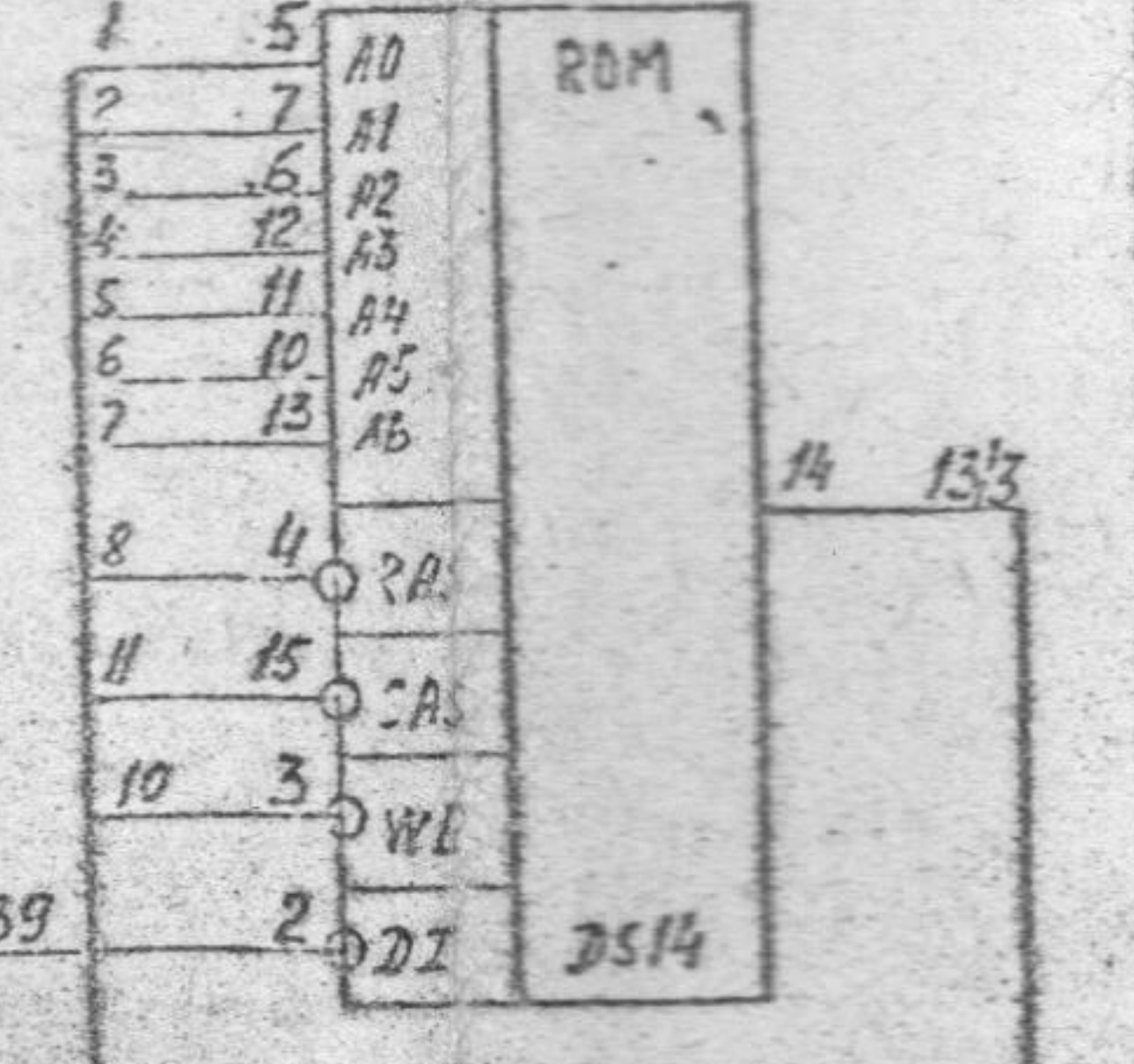
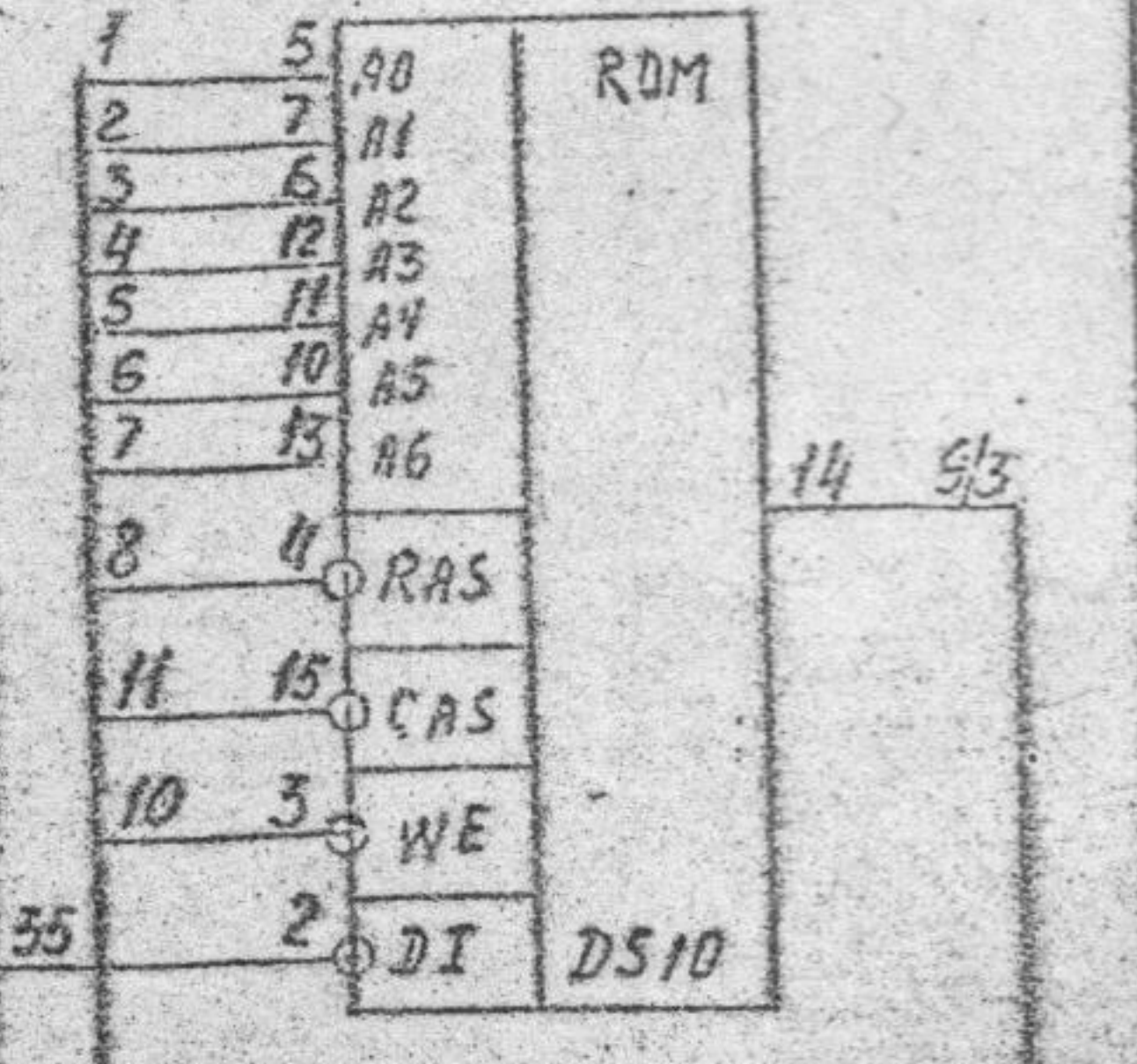
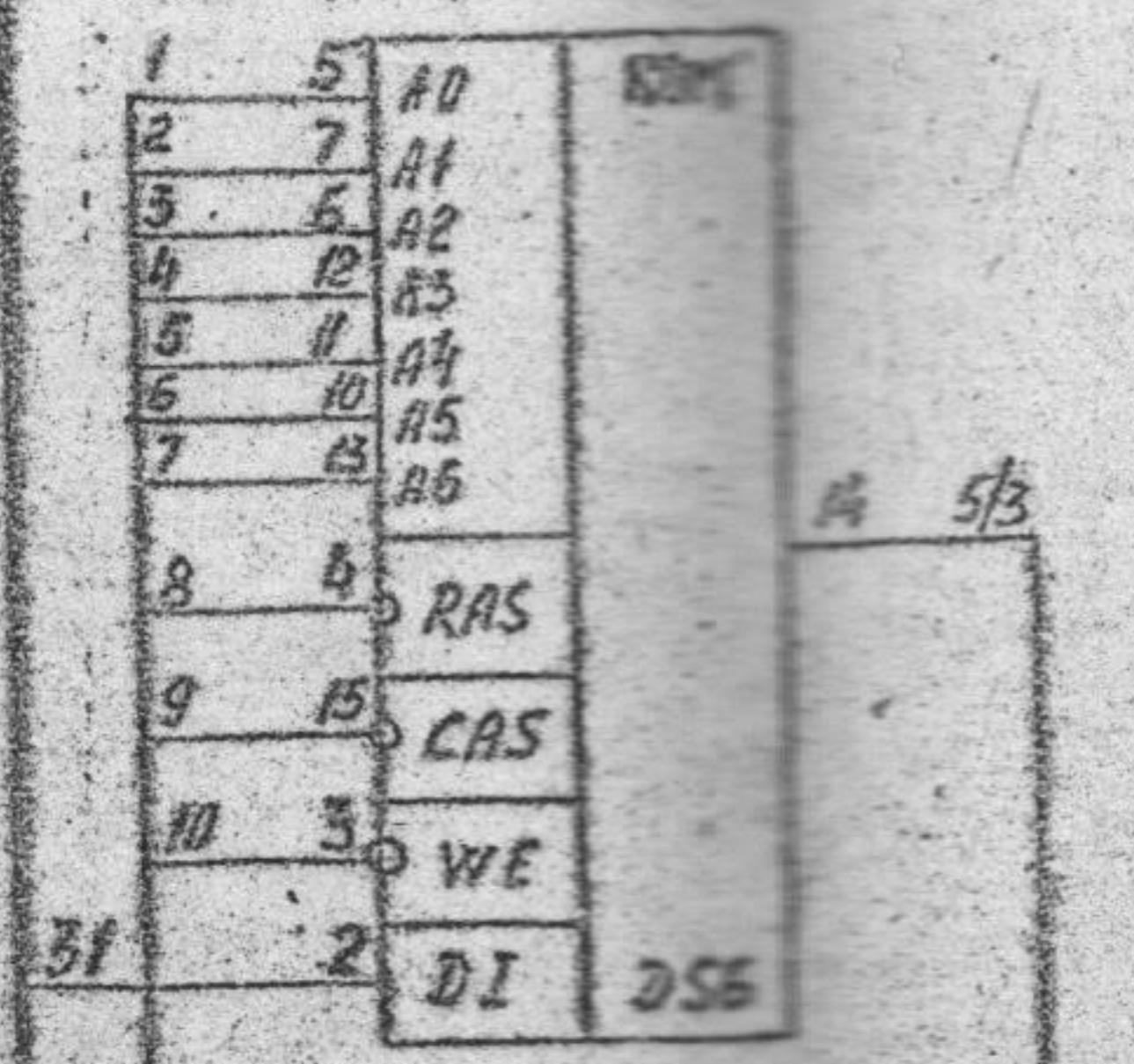
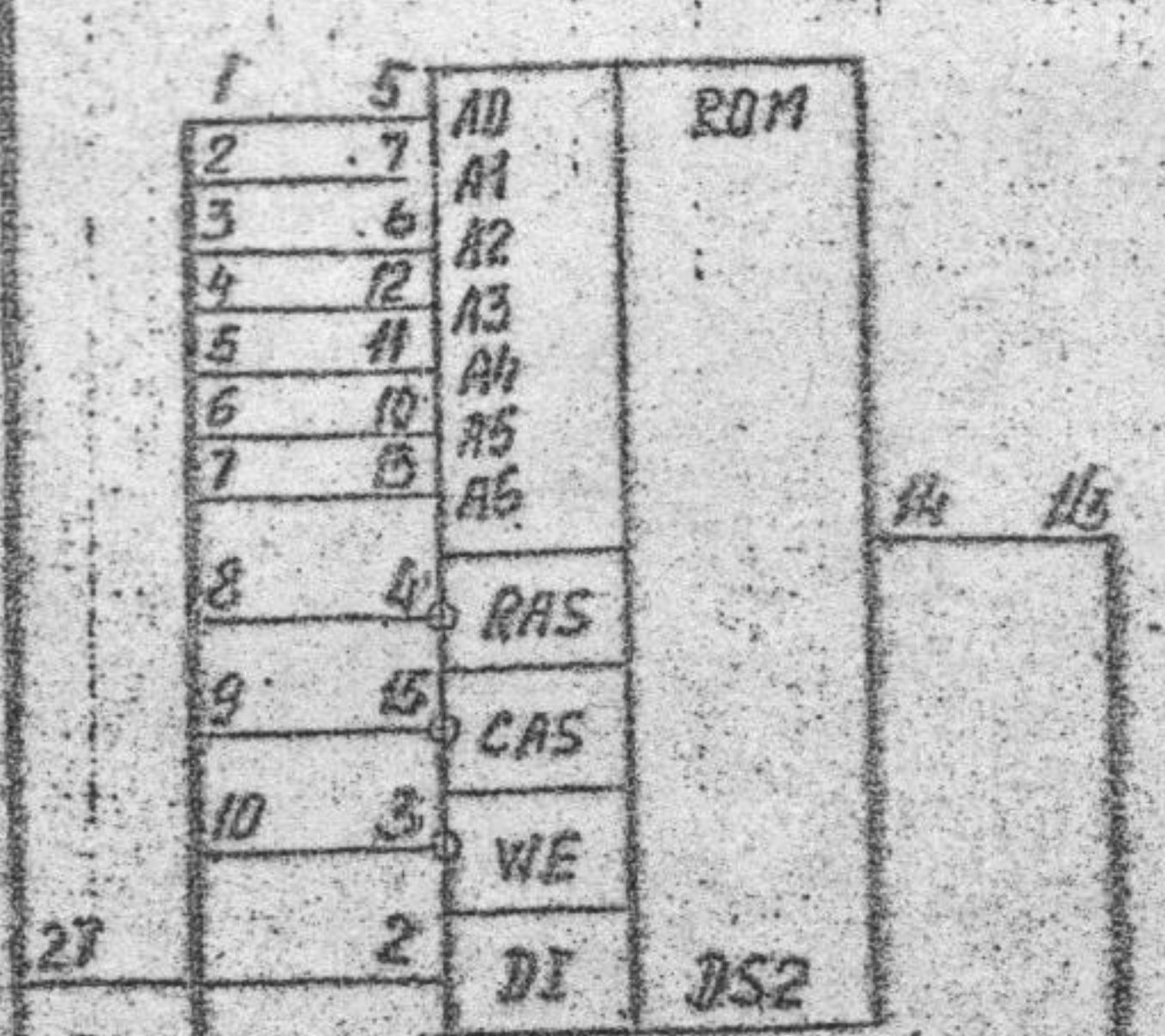

СЭ10-490'650 СМ77